

# Real Good Toys

## America's Collector Quality Dollhouse kits

### Options (not included in the shell kit):

- #1125 Shingle Dye
- SC Copper Flashing
- #T-10 Turntable

### #H-1002K Component Kit, includes:

- |     |        |                            |
|-----|--------|----------------------------|
| (1) | 1001   | 3-in-1 Dollhouse Planbook  |
| (2) | H-1114 | Knob w/ Key Plate          |
| (9) | H-5025 | Louvered Shutter           |
| (4) | H-5032 | Double Hung Window         |
| (5) | H-5041 | Yorktown Window            |
| (5) | H-6007 | Interior Door              |
| (1) | H-6014 | Exterior Door              |
| (1) | H-7000 | Straight Stair Kit         |
| (3) | H-7002 | Dormer w/ Window           |
| (8) | H-7004 | Square Butt Shingle        |
| (8) | H-7009 | Turned Spindles            |
| (2) | H-7011 | Porch Railings             |
| (2) | H-7012 | Newel Posts                |
| (1) | H-7019 | Stair Spindles             |
| (1) | 7035   | 1/4" Clapboard Siding, 24" |
| (4) | 7045   | 3/8" Corner Molding        |



## the 1/2" Front-Opening Georgian Smooth Shell\*

### Dollhouse Kit #H-1002

16<sup>5</sup>/<sub>8</sub>"W x 11<sup>1</sup>/<sub>4</sub>"D x 16<sup>1</sup>/<sub>2</sub>"H

\*The *Finished* 1/2" Georgian pictured above

### Includes:

- H-1002: Shell Kit
- H-1002K: Component Kit (Purchased Separately)

### The Shell Features:

- Front-Opening design
- 3/8" Cabinet grade plywood
- Step-by-Step shell instructions
- 10 rooms (including bathroom and hallways)
- Easy and durable construction
- Handcrafted, pre-cut precision parts

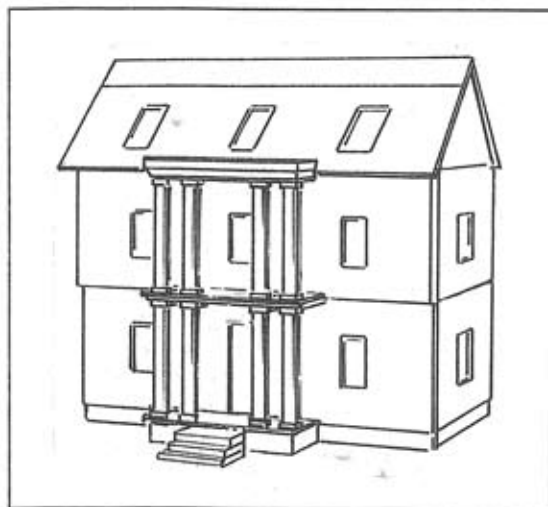

**Assembled Shell**

# The H-1002-K Houseworks Georgian

## House Body

Base floor 15-3/8" x 8-1/4"  
Middle floor 15-3/8" x 8-1/4" with stair hole  
Top floor 15-7/8" x 9-1/2"  
Rear Wall 10-13/32" x 15-7/8"  
2 - Side wall 10-13/32" x 8-1/4" grooved for , with windows  
Back roof 16-1/2" x 7-1/16"  
Top front roof 16-1/2" x 1"  
2 - Side triangles 4-3/4" tall, 9-1/2" base  
2 - Attic partitions 4-3/4" tall, 5-3/4" base  
2 - Foundations 15-5/8" x 1-1/4"  
3 - Foundations 7-5/8" x 1-1/4"  
4 - Dividers 5" x 8-1/4" with door opening  
Divider 5" x 5"  
Divider 5" x 2-1/2" "L" shaped  
2 - Divider 5" x 3/4"  
Upper stair blind 4"  
  
4 - Eave return 3/16" x 1/4" 1-1/4"  
7 - Hinges and 28 - screws

## Yorktown - Colonial Front

Front roof 16-1/2" x 6-7/16" with dormers  
Left upper front 5-1/4" x 10-3/16" with 2 windows  
Left lower front 5-3/4" x 10-3/16" with window, door  
Right upper front 5-1/4" x 5-5/8" with window  
Right lower front 5-3/4" x 5-5/8" with window  
4 - Side blocks 4-5/8" x 1/2"  
Step 3" x 1-1/4"  
Step 3" x 7/8"  
Step 3" x 1/2"

## Georgian Porch

2 - Floor 6-1/2" x 2-1/2"  
Ceiling 6-1/2" x 2-1/8"  
Balcony floor 6-3/4" x 1-7/8" beveled  
Balcony front 6-1/2" x 1/2"  
2 - Balcony side 1-3/4" x 1/2" mitered  
Upper header 6-1/4" x 2"  
Lower header 6-1/4" x 2-3/8"  
16 - Column blocks 11/16" x 11/16"  
Foundation floor 5-3/4" x 2-1/2"  
2 - Foundation side 2-1/2" x 13/16"  
Foundation front 6-7/32" 1-3/16"  
4 - Column (lower) 4"  
4 - Column (upper) 4-3/8"

The H-1002-K Houseworks Georgian

This Dollhouse shell is Real Good Toys' 1/2" scale adaptation of the Houseworks 3-in-1 plan book dollhouse. Real Good Toys developed this house kit to be compatible with Houseworks architectural components.

As you assemble this kit, please don't be confused by the shell as described in the plan book. While the finished product is similar this kit is different from the plan book and these instructions should be used exclusively for the shell.

You may have chosen finishing touches such as wallpaper, flooring or wiring. Plan ahead to determine which stage of assembly is the easiest for adding these things.

Finally, as you go along, don't hesitate to stop working on your house for any reason. This house will last you a lifetime. It is too worthy to rush.

Supplies, Tools, Tips, and Techniques

- A. We recommend that you try a dry run for each section before final assembly to check parts, to see how they locate and to understand the assembly. Then you can comfortably start out again, following the instruction steps - this time - using glue and nails. This dry run will help you avoid mistakes. In the dry run steps, you will understand the overall plan of your dollhouse and how it will work for you.
- B. Whenever possible, mark a butt joint on the panel through which the nail will pass first, then remove the panel and PREPUNCH nail holes from the back side, on center, between marks. This gives a perfectly centered nail in the joint when nailed through the hole from the front and reduces "split out" when final nailing and gluing are done. To PREPUNCH a hole, drive a nail through the panel from the back side and then pull the nail back out.
- C. Glue
  - 1. "Quick Grab" glue is extremely handy for things which can't be nailed or taped while drying. It is the only glue we recommend for gluing on clapboard siding.
  - 2. White or yellow wood glue (such as "Elmers") is an excellent glue for most uses. When applying this glue, squeeze the excess air out of the top of the glue bottle before turning it over. Then when you release pressure from the bottle at the end of a dab or line of glue, the bottle will suck the remainder of the stream of glue back in rather than running it all over your work. Between steps, go back and clean up glue after gluing and nailing. A paintbrush in a water cup may be pinched dry and used to wipe up excess glue.
- D. The stair, window and door holes have rounded corners which must be squared. Use a knife, file or very fine bladed saw and work from the surface inward on both sides to avoid "split out".
- E. A utility knife with a new sharp blade is safer and easier to use than a jack or kitchen knife for trimming, customizing and cutting.
- F. Sandpaper. Use 100 or 120 grit. Sand off any rough edges before assembly.

- G. Hammer (some people prefer tack hammers). Sand the striking surface to reduce bending nails.
- H. Brad Pusher or pliers give more control for small nails than a hammer, and without impact. Set nails the last little bit with a nail set and hammer after the glue is dry.
- I. We have found that sometimes assembly is easier with two people. So. try to have someone around to give you a hand when you need it.
- J. Finally, be sure to follow the instructions exactly when they require keeping things "Square". It is VERY IMPORTANT. If you don't quite understand how to do it, ask someone who does.

The H-1002-K Houseworks Georgian component set is available from your local dealer. This set includes everything you need to finish your dollhouse on the outside and also the interior doors and stairway. Only 1/4" stripwood which is readily available from your dealer is additionally necessary to finish this list. Below you will find a list of components included in the H-1002-K component set. Items are also available individually.

- (6) H-1114 Knob and Keyplate Sets
- (9) H-5025 Louvered Shutter Sets
- (1) H-7000 Straight Staircase Set
- (3) H-7002 Dormer Units
- (8) H-7009 Porch Spindles (12 pcs.)
- (2) H-7011 Porch Railing Sets
- (2) H-7012 Newall Posts (6 pcs.)
- (1) H-7019 Stair Spindles (12 pcs.)
- (1) 7035 1/4" Lap Clapboard Siding (10 pcs.)
- (4) H-5032 Nonworking Glazed Windows
- (5) H-5041 Nonworking Yorktown Windows
- (5) H-6007 Interior Doors
- (1) H-6014 Yorktown 6-Panel Door
- (5) H-7004 Cedar Shingles (400 pcs.)

I. Houseworks "3-in-1" House Body

- A. Draw in the location of dividers as shown below prior to assembly. Lay second floor on top of the smoother side of the base floor and trace stairway opening which helps to locate the divider.
- B. Glue and nail one side panel to the base floor (side panel overlaps the floor). The base floor groove is at the bottom edge of the side panel. Repeat for the other side panel. Use an assistant or the middle panel for support.
- C. Set dividers against side panels to locate the proper height of the middle floor. Make sure stair hole is in proper position (the rear left side). Glue and nail.
- D. Before attaching rear panel you may wish to prepunch a nail hole for the middle floor center by tracing its location and driving a nail through, then pulling it out. Do this with the house on a flat surface with dividers in place. Attach rear panel. Glue and nail.
- E. Glue and nail top floor on top edge of sides and rear. Overlap approximately 1/4" at rear and 3/4" at front (away from stair hole).
- F. Glue and tape triangles to outer edges of top floor, flush at all edges of the triangle. Use dividers to hold them square while they dry.
- G. Attach rear roof and top front roof as shown with attic partitions in place. Center the roof panels side to side making sure the eaves are even.
- H. Tape front roof in place, then mount hinges as shown in illustration #1 on page 3.

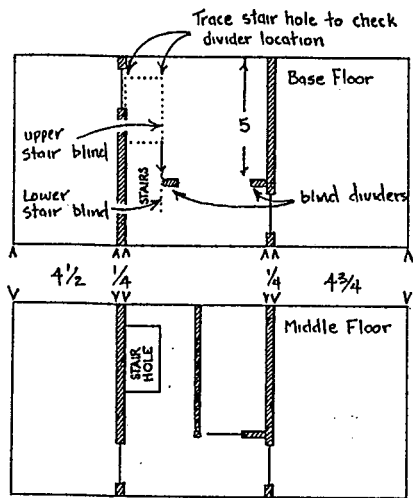

Draw in proper location of dividers before assembly. Stair blinds are for use with the Houseworks stairs which are in the optional finishing components set.

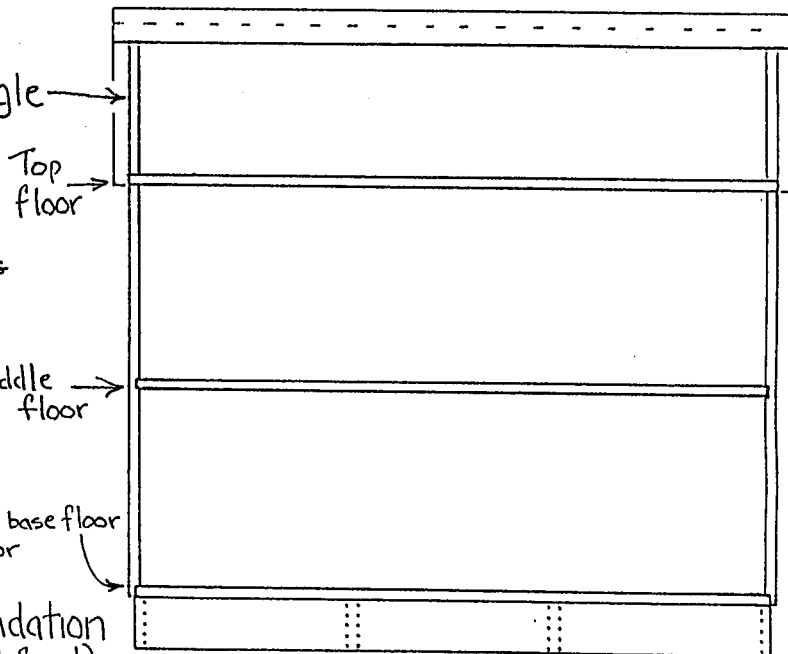
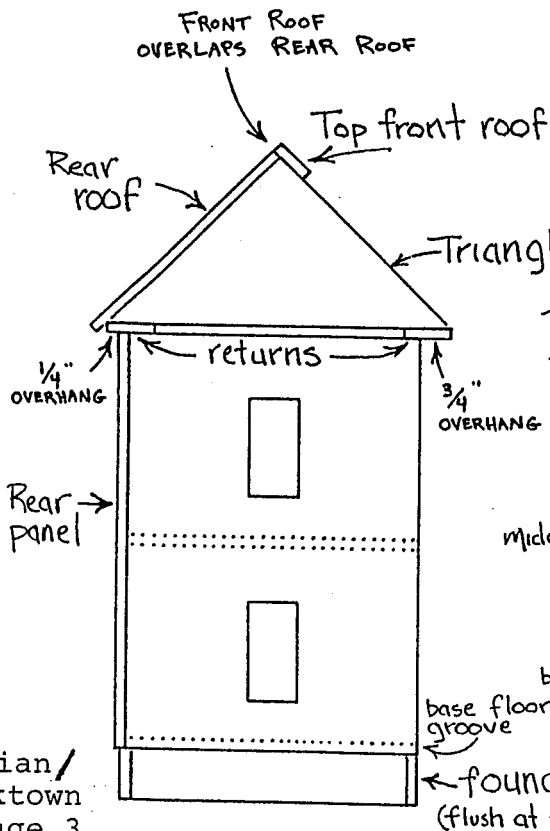
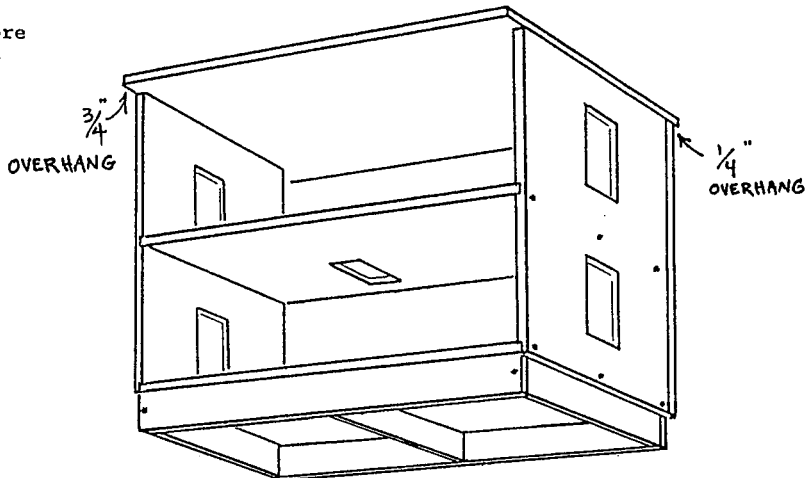

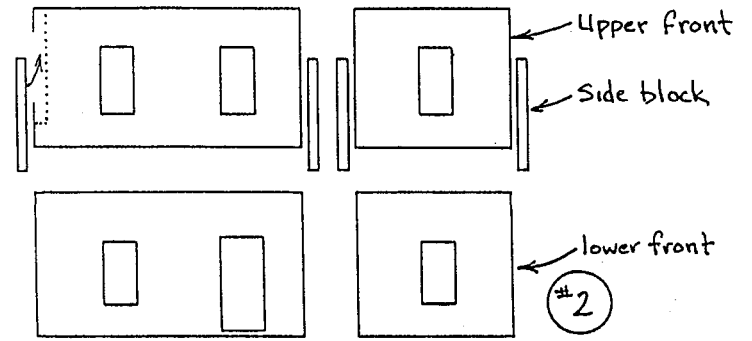
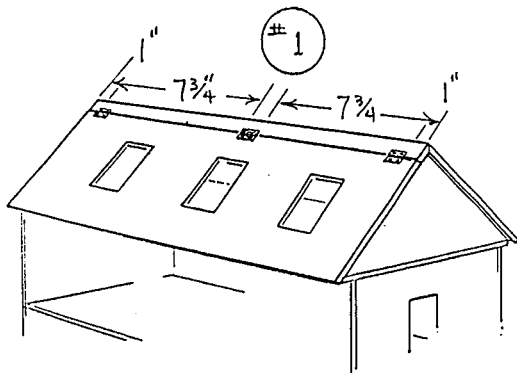

Yorktown - Colonial Front

A. Fronts - Lay out parts as per illustration #2. Window openings are all 1-5/16" from the bottom edge of the front panels.

1. Glue side blocks (4-5/8" x 1/2") to left and right sides of upper front panels flush at the top edge of the fronts and along the side.
2. Front assembly
  - a. Lay the house face down and perform the front assembly on the back panel. Make sure each front assembly is square and the edges straight.
  - b. Glue the upper front assemblies to the lower front panels. Upper front overlaps the lower front and the top edge of the lower front panels butt against the side blocks.

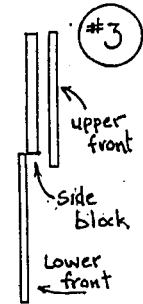

B. Hinges

1. Hinges are screwed to the inner face of the front assemblies, pin down, 1/2" spaced from top to bottom edge, as in illustration #5.
2. Mount front panels on house body - keep panels tight to top floor for swing clearance at the bottom.

C. Front steps - assemble as per illustration #6.

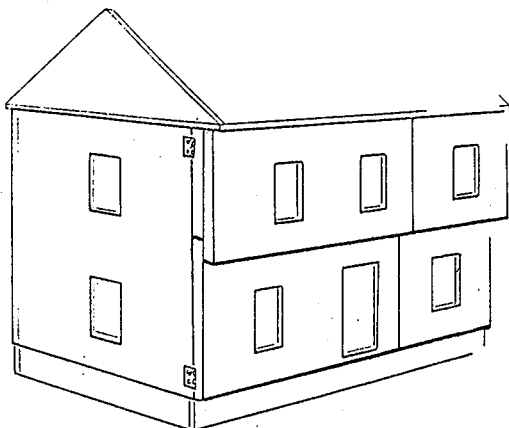
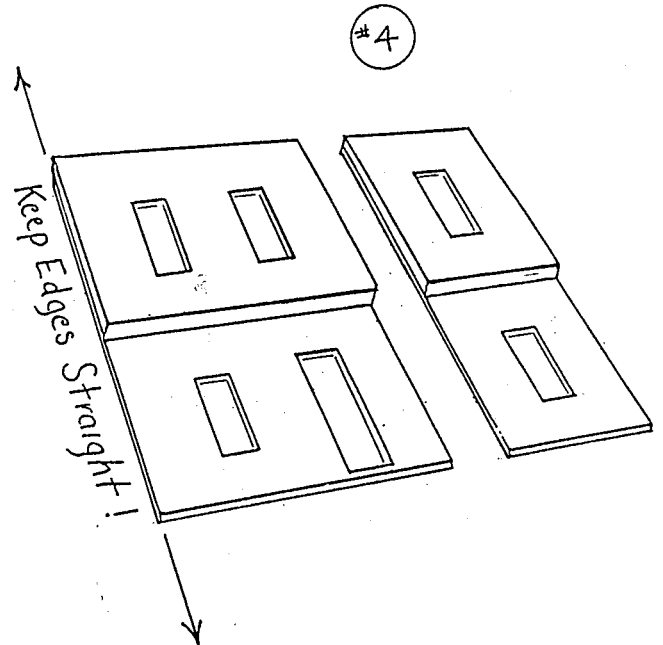
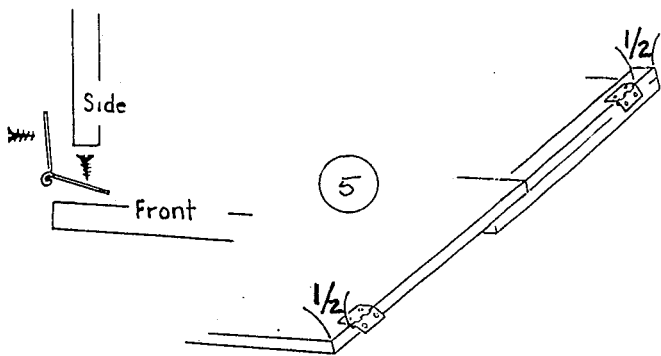

6

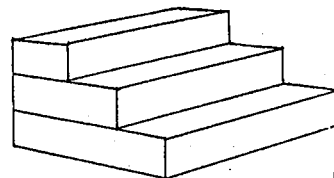

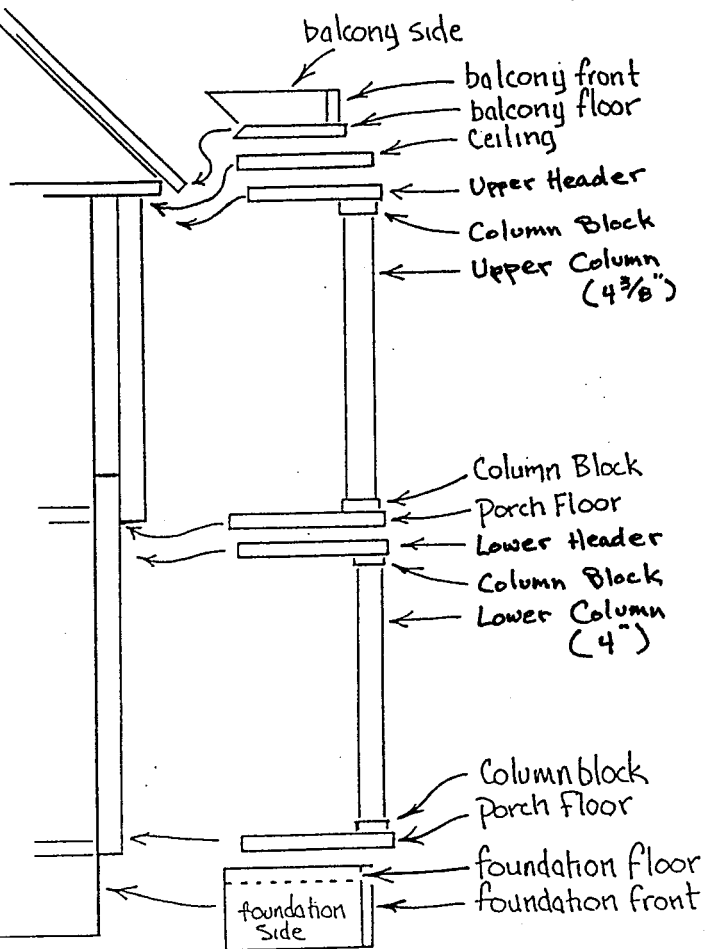

Georgian Porch

A. Columns

1. Sand edges on the column blocks.
2. Glue columns to blocks, centered. Check to ensure blocks are lined up. Illustration #3
3. Let dry.

B. Floors (6-1/2" x 2-1/2")

1. Lay out column location on both porch floors and both column headers, see illustration #2.
2. Separate 2 lengths of column assemblies. Glue them in place (marked in layout) on the porch floors.
3. Glue and nail headers to top of columns. Glue the lower header (6-1/4" x 2-3/8") to the shorter (4") columns. Glue the upper header (6-1/4" x 2") to the long (4-3/8" columns.
4. Nail through floor into columns.
5. Let dry.

C.

1. Lay house on back.
2. Glue ceiling to top of left front panel, centered.
3. Glue long-column assembly to upper left front panel and ceiling.
4. Glue short-column assembly to lower left front panel and floor of upper porch. Make sure columns line up with each other. Let dry.

D.

1. Assemble foundation and glue to house foundation. Do not glue to the porch floor. Let dry.

E.

1. Stand house up.
2. Glue balcony floor (6-3/4" x 1-7/8" beveled) to the house roof in its rest position. Protect the porch ceiling from glue with Saran Wrap.
3. Glue the balcony sides and front in place to the house roof and the balcony floor. Let dry.

#3

