

Dura-Craft, Inc.

P.O. Box 438 • Newberg, Oregon 97132
(503) 538-3136

Assembly Instruction

FH-500 FARM HOUSE

MINIATURE HOUSE KIT

FINISHED SIZE 21" x 40" x 30"

SCALE 1":1'

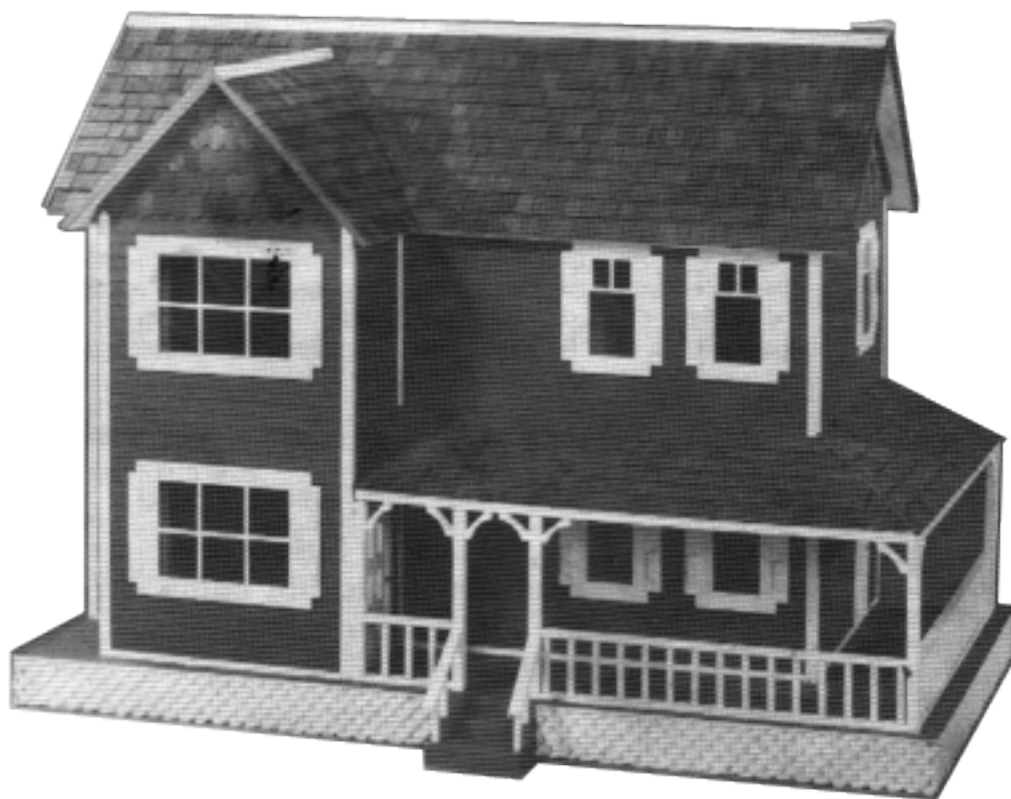

FH-500 FARM HOUSE MINIATURE HOUSE KIT

Congratulations on selecting a miniature house kit manufactured by Dura-Craft, Inc., the leader in the industry.

All pine parts used in our kits are manufactured from the finest kiln dried Ponderosa Pine. We pride ourselves on our high quality and workmanship. Each piece is graded and sorted at several different stages to ensure that you receive the finest quality.

The houses manufactured by Dura-Craft are not modeled after any specific existing houses. Rather they are composites of several different houses, to give you what we feel is a true and accurate representation of the

houses of their style and era.

A Dura-Craft miniature house is a **complete** kit. This means that you do not have to purchase separately items such as siding, window glass, and split cedar shakes, which are a basic part of a house. Your finished house will be ready for painting, wallpapering, and decorating. Dura-Craft does not sell the materials for decorating; however, they should be available through the store where you bought your kit.

Your finished house will be of heirloom quality, of which you will be justly proud, if ample time and care are used in its construction and finishing.

GENERAL INSTRUCTIONS

There are several construction tips that will help you avoid some problems when you build your miniature house.

An important thing to keep in mind about the kit parts: First, they are made of wood. Wood shrinks and expands according to the humidity. We have found that the siding is most sensitive to dimension changes due to humidity. All siding used in Dura-Craft miniature houses is made from the finest kiln dried Ponderosa Pine. However, as a result of changes in siding dimensions brought on by humidity changes, when a wall is assembled with a water base glue, some swelling will occur. Wall panels should be left in a warm dry room at least 48 hours before corner posts are attached. This will prevent walls from cracking. At no time should the house be placed in a cold damp area.

If there is a minor cracking problem, there is a simple solution. A thick bead of white glue should be run into the gap. Wipe off any excess glue and allow to dry. If necessary, repeat this step until the gap is filled. When the house is painted, there will be no evidence of the gap. We recommend a good quality **OIL** base paint be applied on any siding to be painted.

Your Dura-Craft miniature house has been designed

so that you can assemble it with a minimum of difficulty. Some steps require that careful attention be paid to using the correct part.

The kit has been packaged in a way that should assure that all parts are present. The major parts such as siding are easily identified. Other parts will be identified as you go along checking the parts.

There are several steps that must be followed to make the assembly of your house easier. The first is to read through the instructions carefully to get a feeling for the assembly process. Next, using the parts list and parts drawings, check the parts and group them according to the categories used on the parts list. As you do this, you will become familiar with the parts. Also, if any parts are missing or damaged, they can be replaced by Dura-Craft quickly, so that your assembly process will not be held up. Please refer to the missing parts and broken parts order form.

Wall panels do not come assembled in the kit. Follow instructions to assemble wall panels.

NOTE: For shortages or broken parts write directly to Dura-Craft, Inc. for replacement, using the form on the last page of this manual.

SUBASSEMBLY NO. 1 WALL PANELS

1. Prepare your tools and materials. You will need the following items to complete this subassembly:

a framing square
a ruler or tape measure
a pencil
several large books to use as weights
a dispenser of wood-working glue
100 grade (med.) sand paper
a roll of waxed paper
masking tape

2. Locate the parts. You will need the following parts:

1-2, siding 14" 11 pieces
1-3, siding 8 1/4" 10 pieces
1-4, siding 3" 21 pieces
1-5, siding 2 3/4" 4 pieces
1-6, siding 5 1/2" 20 pieces
1-9, siding 1 1/4" 8 pieces
1-11, siding 2" 24 pieces
1-14, siding 8 1/2" 3 pieces
1-16, siding 18 1/2" 6 pieces
1-17, siding 11" 6 pieces
1-28, siding 9 1/2" 6 pieces

3. Prepare the parts for assembly. Finish sand the wood surfaces to remove splinters and rough spots.

4. Pre-assemble the siding *without* glue. Lay the pieces flat side down, as shown in Figure 1. The tongue is on the *top* edge of each board.

5. Use the framing square to insure that the ends of the siding pieces are properly aligned. Measure the widths of the door and window openings *very carefully* and make light pencil marks at the top and bottom of each opening. The proper widths of the door and window openings are given in Figure 1.

6. Prepare an area for gluing. You will need a hard, flat surface at least three feet by four feet in size. Select a location where the wall panels will not have to be disturbed for several hours after gluing. Tape waxed paper over the entire surface.

7. Use the following technique for gluing the wall panels: Apply a thin bead of glue to the tongue then seat it in the groove. Immediately wipe off any surplus glue that squeezes out, using a damp—but *not wet*—cloth. Assemble the panels flat side down on the waxed paper. The panels should be assembled in sections that can be handled easily, as outlined below.

8. Begin with the ground floor section (the first six layers) of wall panels 1-A through 1-G, as shown in Figure 1. Make sure that all parts are arranged in the correct sequence relative to the pencil marks for the door and window openings. (Refer to steps 4 and 5).

9. Make sure that all joints are tight, and that the edges of the walls are square and flush. Place weights on the panels as you finish them. Allow about an hour for the glue to set before moving or adding to the panels.

IMPORTANT: If you must leave the wall panels incomplete for more than two or three hours during this phase of the construction, stand them on edge to allow air to circulate around both sides. This will minimize the likelihood of warping.

10. Add the second story section to the wall panels 1-A through 1-G, as shown in Figure 1. As before, be sure all parts are arranged in the correct sequence, with all edges square.

11. Be sure that all joints are tight, then carefully place weights on the wall assemblies. Allow about an hour for the glue to set before moving the panels.

12. Stand the wall panels on edge to allow air to reach both sides. Let wall panels dry for 24 hours.

FIGURE 1

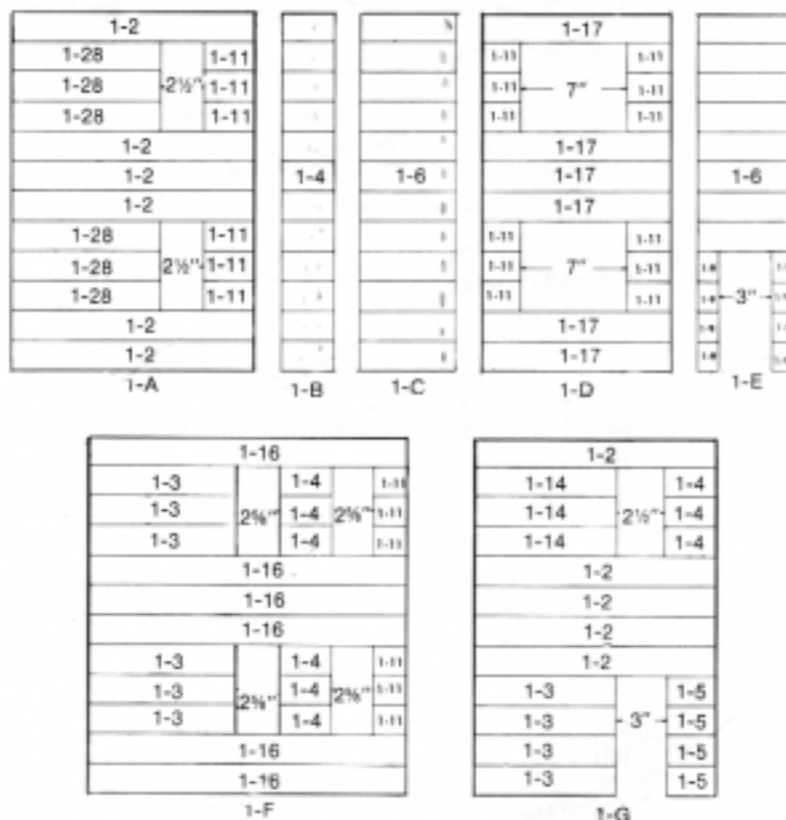

SUBASSEMBLY NO. 2 GABLE ENDS

- Prepare your tools and materials. You will need the following items to complete this subassembly:
 - ½ pint of sealer
 - 1" paint brush
 - thinner
 - a framing square
 - a pencil
 - a dispenser of wood-working glue
 - a roll of waxed paper
 - a sharp utility knife
 - a ruler or tape measure
- Locate the parts. You will need the following parts and subassemblies:
 - 4-13, wing gable 1 piece
 - 4-36, main gable 2 pieces
 - 5-150, shakes (plain)
 - 5-151, shakes (fancy)
 - wall panel 1-A
 - wall panel 1-D
 - wall panel 1-G
- Brush a thin coat of sealer on to the rough side of each of the gables. Allow the sealer to dry.
- Use the utility knife or plane to carefully shave the tongue from the top piece of the siding on each of the wall panels. (1-A, 1-D, and 1-G).
- Lay the two main gables (part no. 4-36) and the one wing gable (part no. 4-13) on the table rough side facing up. Measure 1½ from the bottom of the gables and draw a line parallel with the bottom edge (Figure 2). Now draw lines at one inch intervals the rest of the way up the gable.
- Spread out waxed paper on a flat surface. Apply glue to the top edge of wall panel 1-A, then lay it face up on the waxed paper. Lay the gable (part no. 4-36) in position on top of the wall panel. Be sure the gable overhangs equally on each side of the wall panel as shown in Figure 2. Allow the glue to set.
- Glue the other gable to wall panel 1-G as described in step 6. Allow the glue to set.
- Glue wing gable (part no. 4-13) to top edge of wall panel 1-D as described in step 6. Allow the glue to set.
- Using the first horizontal line as a guide, glue one row of plain shakes (part no. 5-150) over the joints between the gable ends and the wall panels, as shown in Figure 3A. Apply glue heavily under these shakes. Allow the glue to dry before proceeding.

- Glue the fancy shakes (part no. 5-151) onto the gable in the overlapping pattern shown in Figure 3. Let the shakes hang over the edges of the gables until the glue has dried.
- After the glue has thoroughly dried, turn the wall panel face down, and use the utility knife to trim the shakes flush with the gable. Start at the lower corners and cut toward the peak to minimize the chances of splitting the shakes.

FIGURE 2

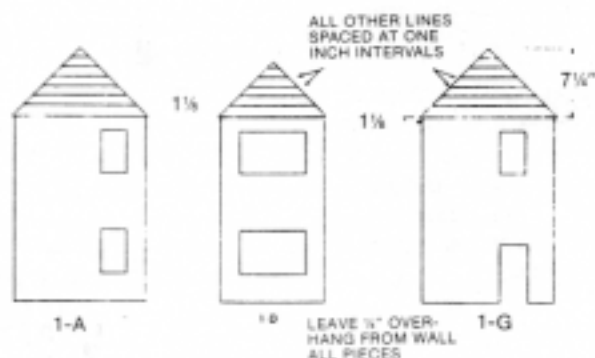

FIGURE 3

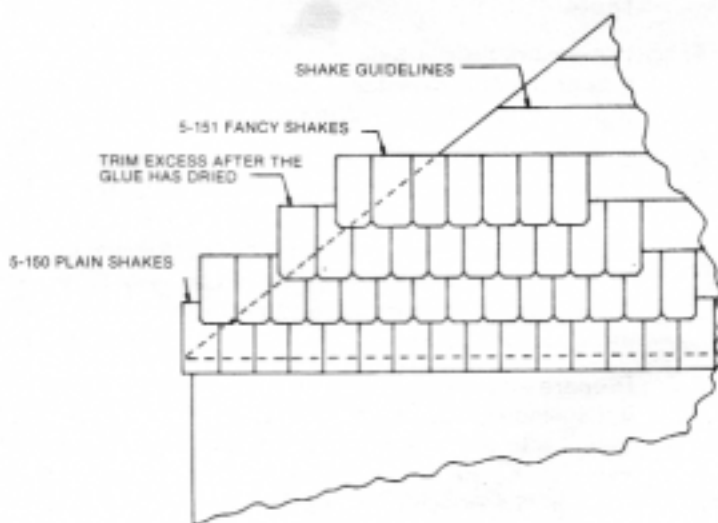
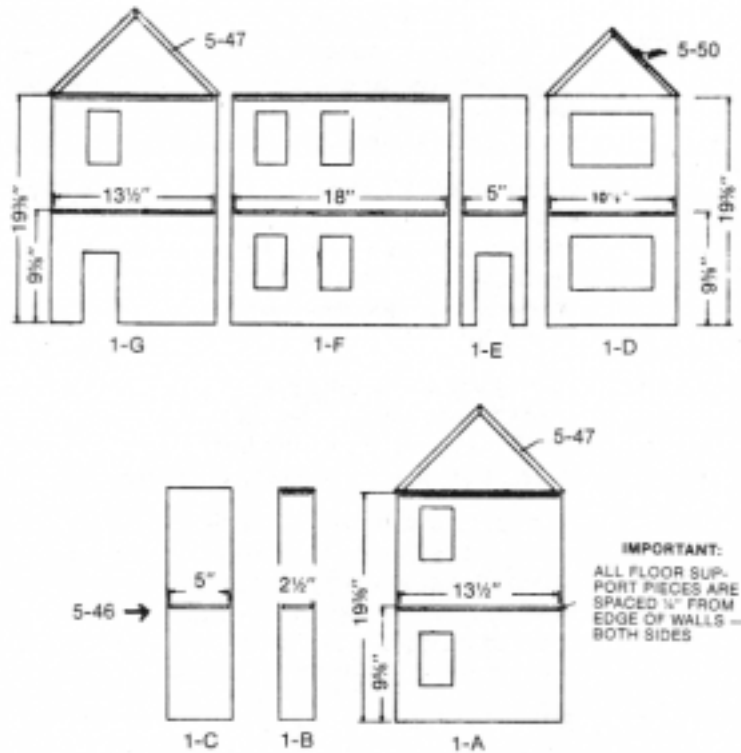

FIGURE 3A



**SUBASSEMBLY NO. 3
FLOOR SUPPORT AND GABLE SUPPORTS**

FIGURE 4



1. Prepare your tools and materials. You will need the following items to complete this subassembly:

- a dispenser of wood-working glue
- a utility knife or coping saw
- a yardstick or tape measure
- a pencil
- 100 grade (med.) sand paper

2. Locate the parts. You will need the following parts and subassemblies:

- 5-46, floor support 5 pieces
- 5-47, main gable support 4 pieces
- 5-50, front gable support 2 pieces
- wall panels 1-A through 1-G

3. Lay the wall panels face down. Measure exactly 9 1/2 inches up from the bottom, and draw a pencil line across each panel at that point. Draw another line 19 1/2 inches up from the bottom.

4. Cut the floor support (part no. 5-46) into pieces of the following lengths:

- 4 pieces 13 1/2" long for wall panels 1-A and 1-G
- 2 pieces 2 1/2" long for wall panels 1-B
- 2 pieces 5" long for wall panels 1-C and 1-E
- 1 piece 10 1/2" long for wall panel 1-D
- 2 pieces 18" long for wall panel 1-F

It is critical that these pieces be no longer than specified, or they may interfere with the installation of the corner post later in the assembly.

5. Glue the floor supports onto the wall panels as shown in Figure 4, so that their upper edges are on the previously drawn lines. Center the floor supports from side to side, so there is a quarter inch space between the end of the floor support and the edges of the wall panels.
6. Glue the gable support (part no. 5-47) in place onto the gables on panel 1-A and 1-G (Figure 4). Glue flush with the edges of the gable. Allow to dry.
7. Glue the front gable supports (part no. 5-50) onto wall panel 1-D (Figure 4). Allow to dry.

**SUBASSEMBLY NO. 4
STANDARD WINDOWS**

1. Prepare your tools and materials. You will need the following items to complete this subassembly:

- a dispenser of wood-working glue
- a tube of model airplane cement
- a utility knife
- 100 grade (med.) sand paper
- a pencil
- a ruler or tape measure
- a roll of waxed paper

2. Locate the parts. You will need the following parts:

- plastic sheets, 2 3/8 x 4 7/8 7 pieces
- plastic sheets, 4 7/8 x 6" 2 pieces
- 2-5, top & bottom window casings 28 pieces
- 2-6, shutters 18 pieces
- 2-7, decorative emblems 36 pieces
- 2-22, window side casings 18 pieces
- 2-29, inside window trim 18 pieces
- 2-30, top & bottom window frames... 14 pieces
- 2-31, large window top & bottom frame 4 pieces
- 5-49, window divider stock
- 2-32, large window top & bottom trim 8 pieces

3. First, we will assemble the small windows (7 required). Using the model airplane cement, glue the top and bottom window frames (part no. 2-30) to the top and bottom of the small plastic sheets. Be sure the window plastic is fully seated in the groove and centered from side to side, as shown in Figure 5.
4. Using model airplane cement, glue the window side casings (part no. 2-22) to the sides of the window. Make sure that the side casings (2-22) contact the top and bottom frames at all four corners. Lay the assemblies face down while the glue dries.
5. After the glue from the preceding step has dried, check the corners to make sure the side casings are flush with the top and bottom frames. Sand them, if necessary, to make them flush.
6. Arrange the window assemblies face down on waxed paper. Use white wood-working glue to attach the shutters (part no. 2-6) to each window assembly. Make sure the shutters are flush top and bottom with the window side casings. Allow the glue to dry before proceeding.
7. Attach the top and bottom window casings (part no. 2-5) to each window assembly. Be sure the casing is centered from side to side, as shown in Figure 6. Allow to dry.
8. Turn the windows face up and install the window dividers (part no. 5-49). They may be installed in any pattern to create whatever style of window you desire (Figure 6). Cut the window divider stock to the required lengths and glue them to the outside of the windows with model airplane cement.
9. Attach the decorative emblems (part no. 2-7) to the shutters (Figure 6).
10. Lay wall panels 1-A, 1-F, and 1-G face up on the table. Apply wood-working glue to the backs of the side and bottom casings, then install the window assemblies in the wall panels. Make sure they are positioned squarely in the opening. Allow the glue to dry before moving the wall panels.
11. After the glue has dried, turn the wall panels over. Glue the inside window trim (part no. 2-29) in place as shown in Figure 7. It should be flush with the window side casings (part no. 2-22), and should cover the gap between the casing and wall panel.
12. After the glue on the trim has set, install the top and bottom window casings (part no. 2-5) as shown in Figure 7. The ends should overhang evenly left and right.
13. Next, we will assemble the large windows (2 required). Using model airplane cement, glue the large top and bottom window frames (part no. 2-31) to the top and bottom of the large plastic sheets. Be sure the window plastic is fully seated in the groove and centered from side to side, as shown in Figure 8.
14. Using model airplane cement, glue the window side casing (part no. 2-22) to the sides of the window. Make sure that the casings contact the top and bottom frames at all four corners. Lay the assembly face down while the glue dries.
15. After the glue from the preceding steps has dried, check the corners to make sure the side casings are flush with the top and bottom frames. Sand them, if necessary, to make them flush.
16. Arrange the window assemblies face down on waxed paper. Use wood-working glue to attach the shutters (part no. 2-6) to the window assembly. Make sure the shutters are flush to the top and bottom of the window side casings. Allow the glue to dry before proceeding (Figure 9).
17. Attach the large window top and bottom casing (part no. 2-32) to the window assemblies. Be sure the casings are centered from side to side as shown in Figure 9. Allow to dry.
18. Turn the windows face up and install the window dividers (part no. 5-49). They may be installed in any pattern desired (Figure 9). Cut the window divider stock to the required lengths, and glue them to the outside of the windows with model airplane cement.
19. Attach the decorative emblems (part no. 2-7) to the shutters (Figure 9).

FIGURE 5

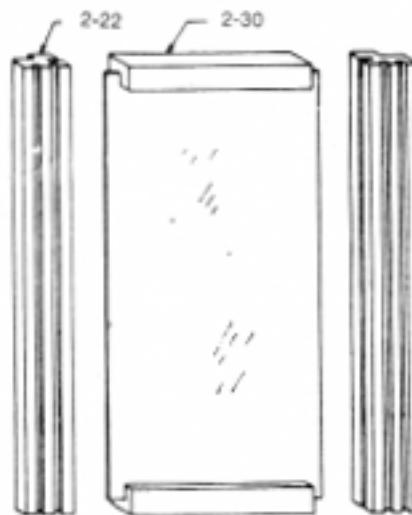

**SUBASSEMBLY NO. 5
STAIRWAY AND RAILING ASSEMBLY**

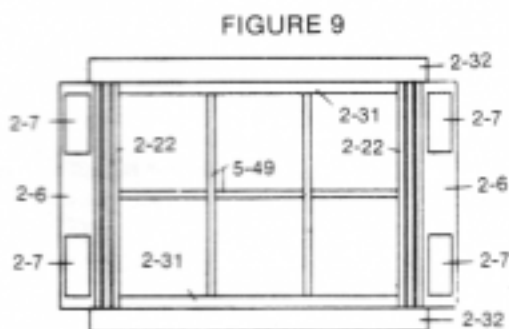
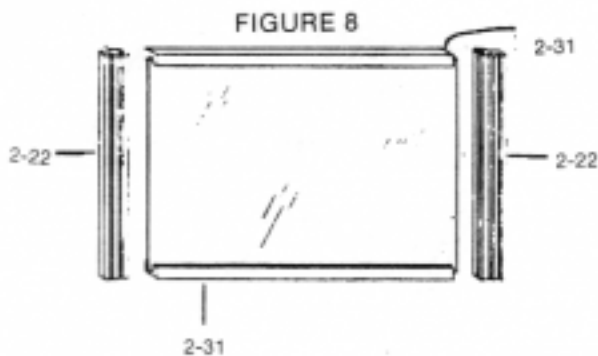
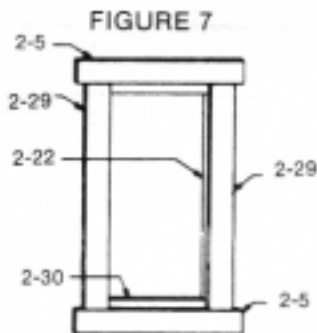
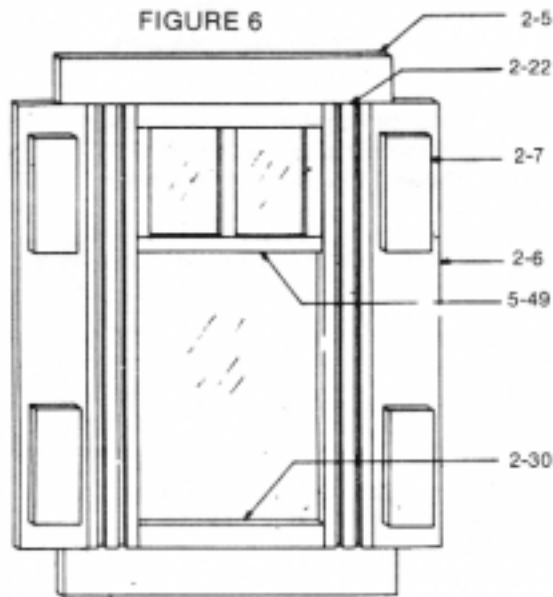

1. Prepare your tools and materials. You will need the following items to complete this subassembly:
a dispenser of wood-working glue
a roll of waxed paper
a ruler
a pencil
2. Locate the parts. You will need the following parts and subassemblies:
5-70, bannister stock..... 3 feet
6-2, bannister posts.....30 pieces
6-13, stairway base 1 piece
6-14, steps13 pieces
3. Lay the stairway base (part no. 6-13) rough side up and spread glue evenly over the entire surface.
4. Position the bottom step (part no. 6-14) so the angle-cut side seats in the glue at one end of the stairway base as shown in Figure 10.
5. Apply glue to the bottom (the smallest side) of the next step as shown in Figure 10, then lay it in place. It should be in full contact with the stairway base and the bottom step.
6. Attach the remaining steps in succession, following the same procedure, spacing them evenly to fill the full length of the stairway base. Be sure all the edges are flush. Allow the glue to set.
7. Cut four 3¼" pieces of bannister stock (part no. 5-70). Lay them out and make pencil marks every half inch next to the grooves. These mark the locations for the bannister posts.
8. Apply glue to the ends of the bannister posts (part no. 6-2) and install them in the bannisters as shown in Figure 10. Line up the posts with the pencil marks. Be sure the ends of the assemblies are square!
9. Stand the stairway assembly on edge on a sheet of waxed paper as shown in Figure 11.
10. Apply glue to the lower half inch of the bannister posts, and then lay them in position against the steps. Refer to Figure 11.
11. Cut one 12" piece of bannister stock (part no. 5-70). After the glue from step 10 has dried, lift the assembly off the waxed paper. Apply a dab of glue to the end of each post, then install the bannister piece. Its lower end should be flush with the bottom post and the upper end should overhang about an inch.

FIGURE 10

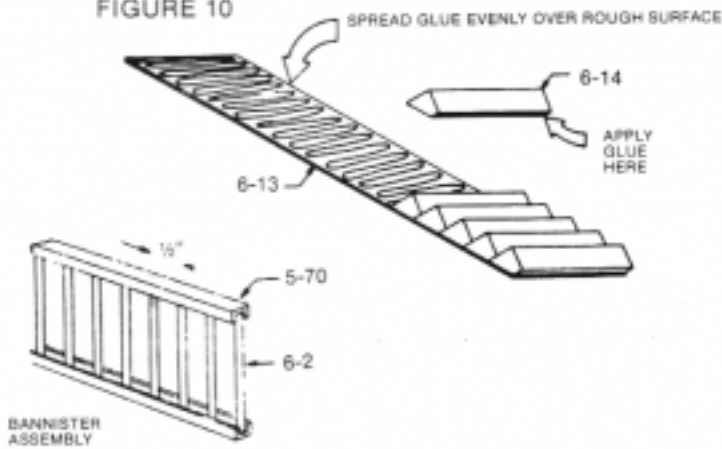
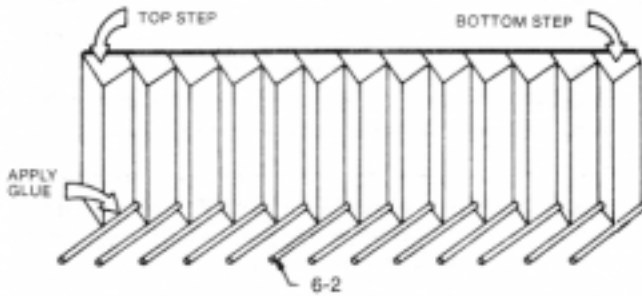

FIGURE 11



**SUBASSEMBLY NO. 6
HOUSE BASE**

1. Prepare your tools and materials. You will need the following items to complete this subassembly:
a dispenser of wood-working glue
a roll of waxed paper
masking tape
2. Locate the parts. You will need the following parts:
3-2, base 14½ x 31½ 1 piece
3-3, front base 6½ x 31½ 1 piece
3-6, foundation strip, 20¼" 3 pieces
3-10, side base 8½ x 21 1 piece
3-11, foundation strip 20" 4 pieces
3. Prepare an area for gluing. You will need a hard flat surface at least 21" x 40" in size. Select a location where the assembly will not have to be disturbed for 12 hours after gluing. Tape waxed paper over the entire surface.

4. Glue the three base pieces (3-2, 3-3, 3-10) together as shown in Figure 12. Apply the glue heavily to the mating surfaces, then press them together firmly.
5. After the glue from step 4 has set, glue the foundation strip pieces (part no 3-11) in place as shown in Figure 12. Tape them in place if necessary.
6. When the glue from step 5 has set, glue the foundation strip (part no. 3-6) in place as shown in Figure 12.

FIGURE 12

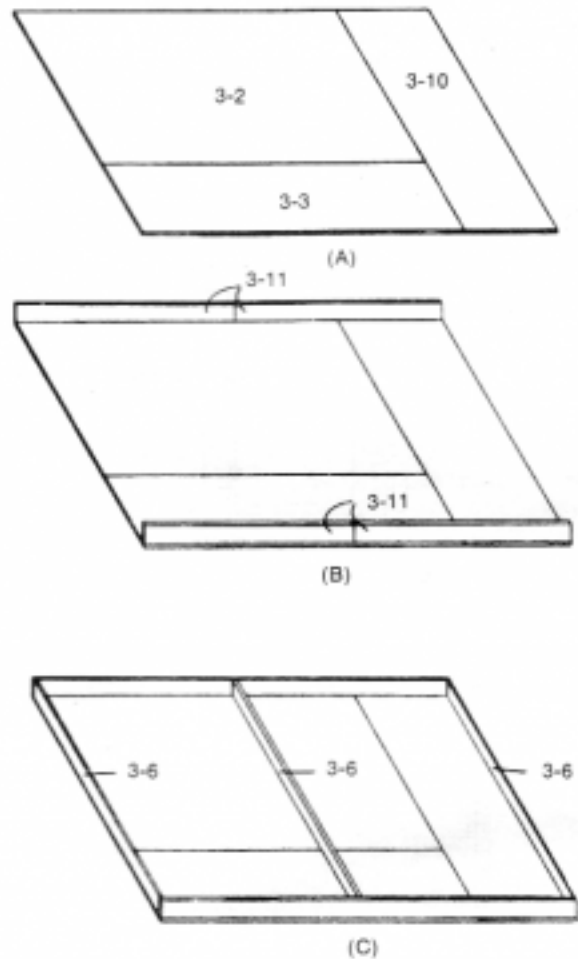

SUBASSEMBLY NO. 7 PORCH RAILING AND PORCH ROOF SUPPORTS

1. Prepare your tools and materials. You will need the following items to complete this subassembly:

a dispenser of wood-working glue
masking tape
a utility knife
a roll of waxed paper
a ruler or tape measure
a coping saw
a framing square
rubber bands

2. Locate the parts. You will need the following parts and subassemblies:

5-25, porch roof support 5 pieces
5-46, floor support stock
5-24, side porch roof support 1 piece
5-52, front porch roof support 1 piece
6-4, porch railing stock 8 feet
6-6, porch railing posts 40 pieces
6-12, decorative gussets 6 pieces
wall panels 1-E, 1-F, 1-G

3. Lay wall panels 1-F and 1-G face up on the table. Count down from second floor window to fifth ridge under window. Cut floor support stock (1 piece) 18" long. Cut another piece of floor support 13½" long. Glue these pieces on wall panel 1-F and 1-G as shown in Figure 13, centered side to side.

4. Cut the porch railing stock into pieces of the following length:

2 pieces — 3" long
2 pieces — 16½" long
2 pieces — 19½" long

5. Lay out the 16½" pieces. Starting from one end, measure and mark next to the groove every 1". These mark the location of the posts.

6. Apply glue to the ends of the porch railing posts (part no. 6-6) and install them in the railings. Be sure the end of the assemblies are square.

7. Repeat steps 5 and 6 for 3"-long parts and for 19½"-long parts.

NOTE: On the two 16½"-long pieces and two 19½"-long pieces, the last mark will be 1½" from the end. This will not be evident when the house is assembled. Hold the assemblies with rubber bands until the glue dries.

8. Spread waxed paper over an area large enough to lay out the two porch assemblies shown in Figure 14.

9. Check the ends of the railing assemblies to ensure that the top and bottom rails are exactly square with one another. Square them up with sandpaper if necessary.
10. Apply glue to the ends of the 3" pieces, then lay them on the waxed paper and position two porch supports (part no. 5-25) against them as shown in Figure 14. Allow the glue to dry.
11. Apply glue to the ends of the 16½" section of railing, then lay it on waxed paper and position a post (part no. 5-25) against each end as shown in Figure 14. Allow the glue to dry.
12. Apply glue to the right end of the 19½" section of railing and position the final post (part no. 5-25) as shown in Figure 14. Allow the glue to dry.
13. Apply glue to the tops of the porch roof supports (part no. 5-25), then position the porch roof supports, (part nos. 5-52 and 5-24) as shown in Figure 14. The narrow edge should be at the bottom as shown in the drawing with the assemblies face down on the waxed paper.
14. Glue the decorative gussets (part no. 6-12) in place as shown in Figure 14. Allow the glue to thoroughly dry before lifting the assemblies from the waxed paper. Handle these assemblies very carefully until they are installed in the house during final assembly.

FIGURE 13

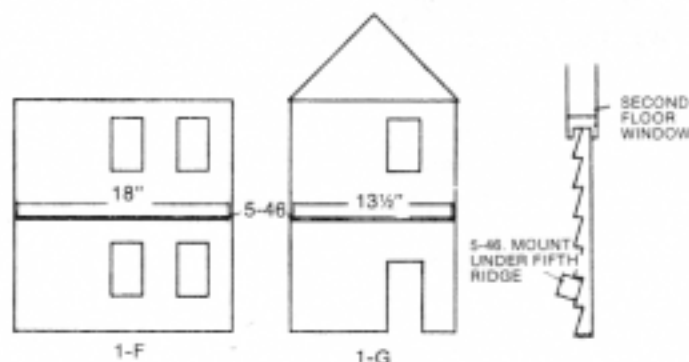
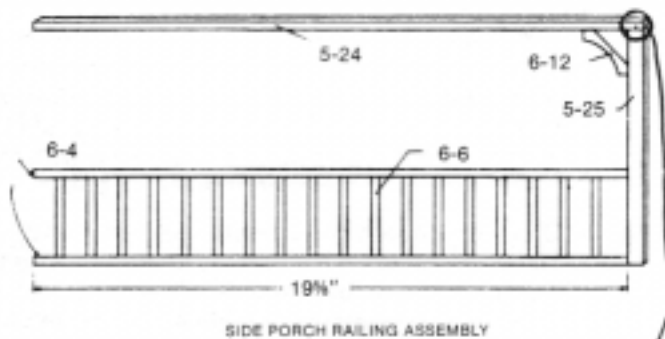
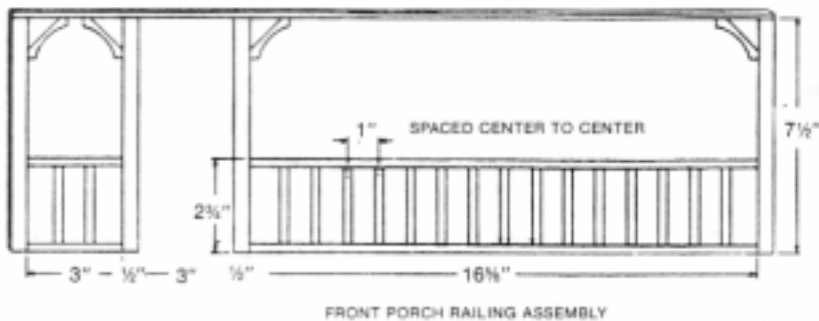
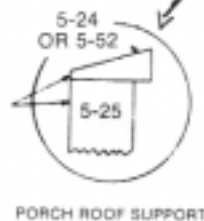

FIGURE 14



THESE PIECES MUST BE FLUSH ON OUTSIDE EDGE



FINAL ASSEMBLY PART 1 WALLS, FLOORS AND BASE

1. Prepare your tools and materials. You will need the following items to complete this phase:
 a dispenser of wood-working glue
 a pencil
 "T" pins or straight pins
 string
 several large rubber bands
 a framing square
 masking tape
 a coping saw
 one pint of contact cement (not water base)
 scissors
 a 3/32 diameter nail set (optional)
 1/2 pint sanding sealer
 thinner
 polyurethane varnish (satin finish)
 100 grade (med.) sand paper
 steel wool

2. Locate the parts. You will need the following parts and completed subassemblies:

4-37, 2nd floor	1 piece
4-38, attic floor	1 piece
4-39, front wing floor	1 piece
5-1, rear corner posts	2 pieces
5-2, front corner posts	6 pieces
5-51, rear floor trim	2 pieces
5-3, universal molding stock	
5-51, rear floor trim	1 bundle
Hardwood flooring	
Wall panels (all)	
Base subassembly	

3. Cut a quarter-inch notch out of two corners of wing floor (part no. 4-39). Cut a 1/2" x 1/4" notch out of the other two corners as shown in Figure 15.
 4. Assemble wall panels 1-C, 1-D and 1-E by applying glue to the grooves in the corner posts (part no. 5-2). Be sure the grooves in the corner posts are all pointed the right direction, as shown in Figure 16. Carefully seat the wall panels all the way into the grooves.
 5. Apply a bead of glue to the top surface of the floor supports. Lay the front wing floor (part no. 4-39) in place, smooth side up, and press it gently into the glue.
 6. Tie strings around the assembly as shown in Figure 16. Use rubber bands to keep the string tight. This will keep the wall panels pulled in against the floor. Stick pins into the wall panels at floor level to wedge the floor down against the floor supports.
 7. Cut notches in the two floor panels (part nos. 4-37 and 4-38) as shown in Figure 17. The notches in the corners are 1/4" square and the other notches measure 1/2" x 1/4".
- NOTE:** The glue from all preceding steps in this sequence must be dry before proceeding. Remove all strings, pins, etc.
8. Assemble wall panels 1-A, 1-B, 1-F and 1-G as shown in Figure 18. Seat the wall panels all the way into the grooves, then tape the corner together on the outside of the house. Before the glue sets, proceed with step 9.
 9. Apply a bead of glue to the top surface of the floor supports. Lay the main floor panels (part nos. 4-37 and 4-38) in place, smooth side up, and press them gently into the glue.

11. Glue the rear floor trim (part no. 5-51) in place across the rear edge of the second and attic floors.
12. When the glue is dry, position the house on the base subassembly, as far to the right as possible, with the rear corner posts flush with the back edge of the base, as shown in Figure 19.
13. Mark the location of the house on the base with a pencil line across the inside and outside of the walls. Lift the house off the base.

NOTE: The hardwood flooring kit contains enough hardwood strips to cover one floor of the house. This material may alternatively be applied to the door, stairways, or used as wall paneling. If you do not plan to apply the hardwood to the floor, skip steps 14 through 18.

14. Brush contact cement on the base inside the pencil line that marks the location of the walls, and on one side of the hardwood strips. Follow the instructions provided with the cement.

NOTE: Contact cement is extremely volatile and flammable. The working area must be well ventilated. Keep away from flame or sparks!

15. Start laying hardwood strips at the front of the house and work toward the rear. Cut the strips with scissors. Off-set the joints as shown in Figure 20.
16. After the hardwood strips are in place, burnish them down by rubbing them firmly with a small wood block.
17. To achieve a pegged appearance, if desired, punch the ends of each strip with a $\frac{3}{32}$ " nail set, as shown in Figure 20.
18. Sand the flooring smooth and remove any traces of contact cement that would interfere with the positioning of the house on the base.
19. Apply a bead of white wood-working glue between the two lines drawn in step 13. Carefully place the house into the bead of glue. Be careful to avoid getting any glue on the unfinished hardwood flooring! Lay weights on the upper floors to hold the house in position. Proceed immediately with step 20.
20. Before the glue from step 19 dries, cut the pieces of universal molding (part no. 5-3) to fit around the base of the walls on the inside and outside of the house. At the doorways, cut the molding a quarter inch short to allow clearance for the door casings (Figure 21).
21. When the glue is dry, finish the hardwood flooring with two or three coats of satin sheen polyurethane varnish. Steel wool lightly between coats.

FIGURE 15

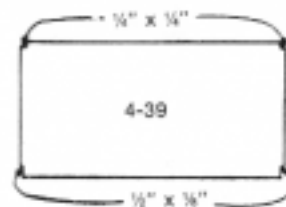

FIGURE 16

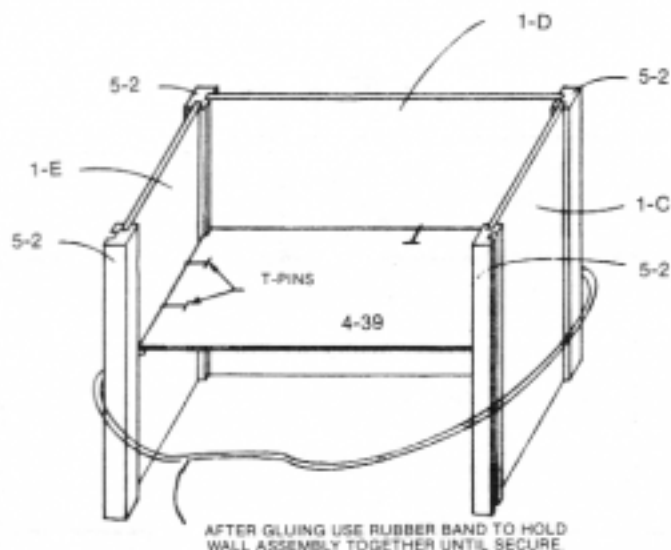

FIGURE 17

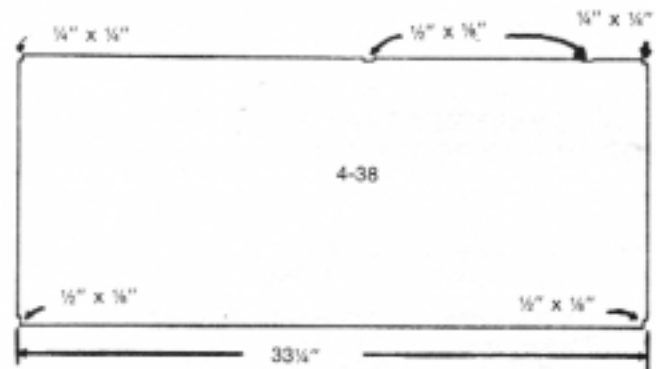
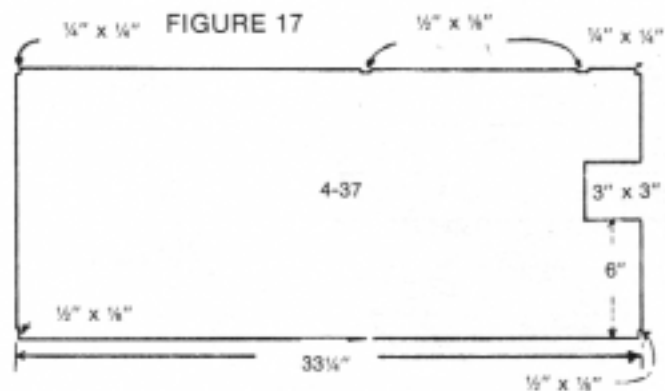

FIGURE 18

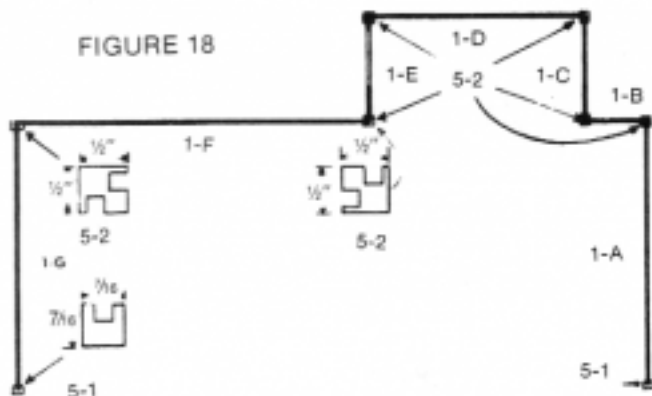

FIGURE 19

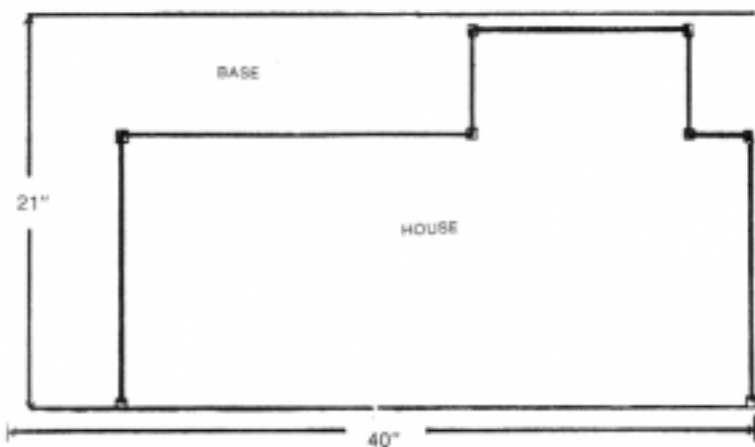

FIGURE 20

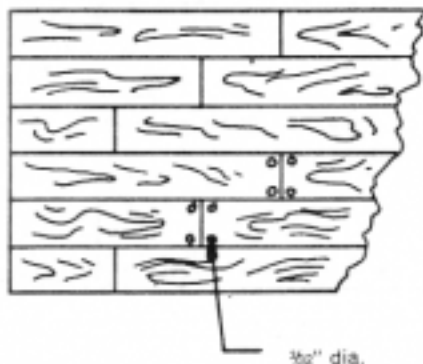
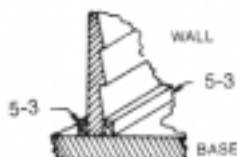

FIGURE 21



FINAL ASSEMBLY PART 2 PORCH AND PORCH ROOF

1. Prepare your tools and materials. You will need the following items to complete this phase:
 - a dispenser of wood-working glue
 - a small square
 - masking tape
 - a pencil
 - a yard stick
 - a sharp utility knife

2. Locate the parts. You will need the following parts and completed subassemblies:
 - 4-17, side porch roof..... 1 piece
 - 4-40, front porch roof..... 1 piece
 - 5-150, shakes (plain).....
 - 6-7, porch step, lower..... 1 piece
 - 6-8, porch step, upper..... 1 piece
 - 6-12, deco gusset..... 1 piece
 - porch railing subassembly, front
 - porch railing subassembly, side
3. Lay out the two porch roof panels, rough side up (part nos. 4-17 and 4-40) as shown in Figure 22. Carefully measure and draw lines for applying the shakes. The first line goes 1 1/8" in from the front edge, and the rest are 1 inch apart.
4. Apply glue to the bottom surface of the porch railing front assembly. Then position it parallel with the front edge of the base and attach to the corner post (part no. 5-2) where wall panels 1-D and 1-E meet, as shown in Figure 23.
5. Apply glue to the bottom surface of the porch railing side assembly. Then position it parallel with the side edge of the base and attach to the porch roof support (part no. 5-25) at the corner of the base (see Figure 23). Tape the two railing assemblies together at the corner.
6. Use the square to make sure that both the railing assemblies are standing vertically. Allow the glue to dry before proceeding with step 7. Attach decorative gusset (part no. 6-12) in place. Hold with tape.
7. Fit the porch roof panels (part nos. 4-17 and 4-40) in place on the porch roof supports. You will have to cut notches to fit the panels around the corner posts (Figure 24).
8. When proper fit is assured, apply glue to the porch roof supports and permanently install the porch roof panels.
9. After the glue dries, apply shakes (part no. 5-150) over the entire roof. Start at the outer edge of the roof panels and work upward toward the house. Align the top edges of each course of shakes with pencil lines drawn in step 3. At the joint where the two porch roofs meet, cut the shakes at the same angle as the seam.
10. Slip a small sheet of waxed paper under the base directly in front of the gap in the front porch railing assembly. Glue the porch steps (part nos. 6-7 and 6-8) against the front edge of the base, centered on the opening.

FIGURE 22

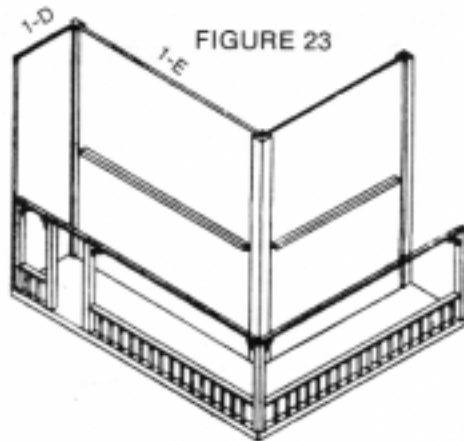
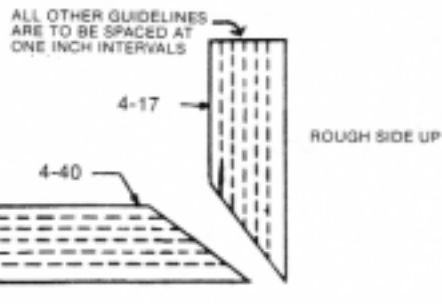
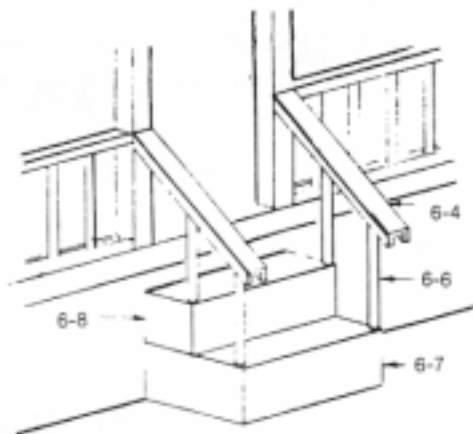
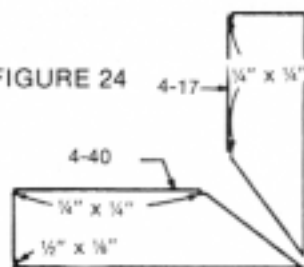

FIGURE 24



FINAL ASSEMBLY PART 3 ROOF

Prepare your tools and materials. You will need the following items to complete this phase:

- a dispenser of wood-working glue
- a sharp utility knife
- a coping saw
- a yard stick
- a pencil
- a framing square
- a roll of waxed paper

2. Locate the parts. You will need the following parts and completed subassemblies:

4-8, rear roof panel	2 pieces
4-15, front wing roof	2 pieces
4-41, main roof panel	1 piece
5-19, universal shake trim	9 feet
5-22, front wing roof ridge cap	1 piece
5-26, chimney stack	1 piece
5-28, chimney top	1 piece
5-53, main roof ridge cap	1 piece
5-95, fillet molding	1 piece
3. Place all roof panels rough side up and carefully measure and draw guide lines on all the panels for applying the shakes. The first line goes 1 1/2" up from the bottom and the rest are 1 inch apart as shown in Figure 25.
4. Glue the main roof ridge cap (part no. 5-53) across the top edge of the main roof panel (part no. 4-41).
5. When the glue from step 4 is dry, prop the main roof panel in a vertical position with the ridge cap laying on the table as shown in Figure 26. Glue the rear roof panels (part no. 4-8) in place, rough side down. Make certain that the front and rear roof panels join at a 90° angle to one another.
6. Glue the fillet molding (part no. 5-95) across the top floor panel as shown in Figure 27. Be sure it is sloped in the same way as the gables.
7. When the glue from steps 5 and 6 has dried, trial fit the main roof assembly. Trim the tops of the corner posts as required to match the pitch of the roof and ensure that the roof panels will fit tightly against the gables and fillet moldings.
8. Apply glue to the gable support and fillet molding as indicated by the dashed lines in Figure 28-A. Position the main roof panel as shown in Figure 28-B, centered side to side so that there is an equal overhang on the gables.

IMPORTANT: Make sure that the gables are at a 90° angle to the top floor.
9. Assemble the front roof panels using the same method outlined in steps 4 and 5. Refer to Figure 29.
10. Trim corner posts (part no. 5-2) on front wing of house and fit assembled front wing roof and front wing gable. Where the roof meet, make sure that the bottom edges are flush.

11. Glue front wing roof in place. Apply glue to all points that touch, referring to Figure 30.
12. After the glue dries, apply shakes (part no. 5-150) over entire roof. Start at the bottom edge of each panel and work toward the top, staggering the shakes in each row. Align the top edges of each course of shakes with the guidelines drawn earlier.
13. Cut and install the universal shake trim (part no. 5-19) on the edges of all roof panels as shown in Figure 31.

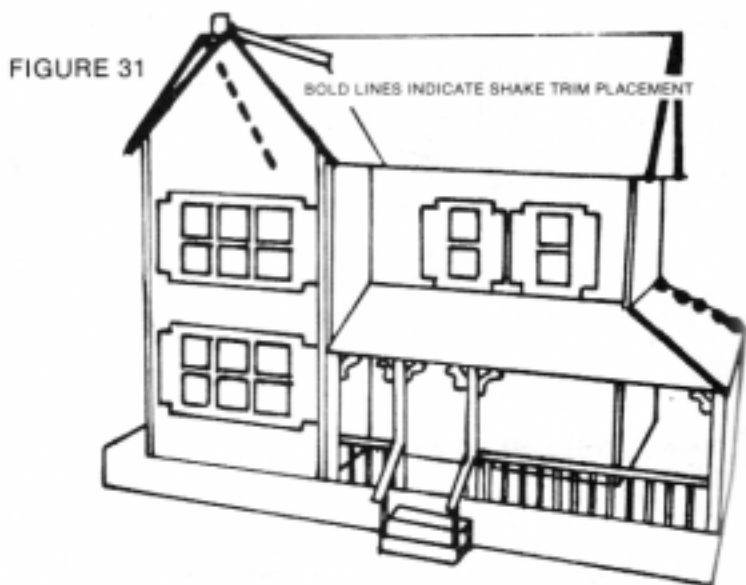
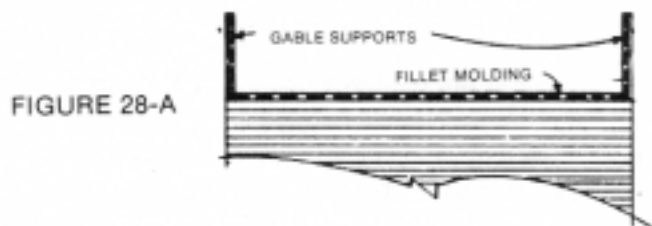
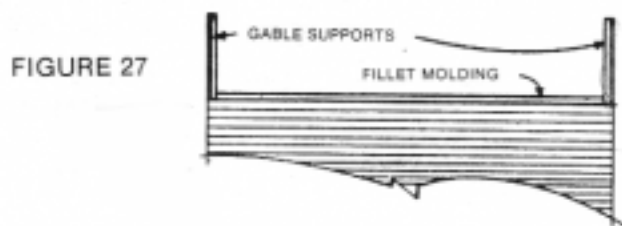
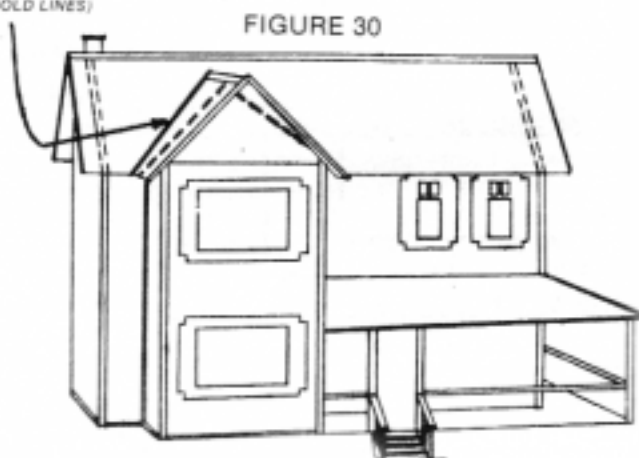
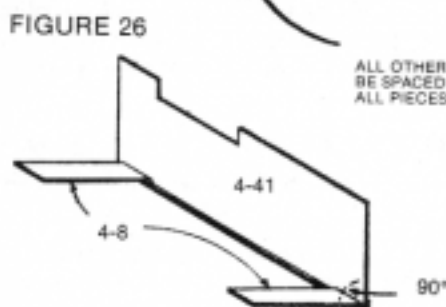
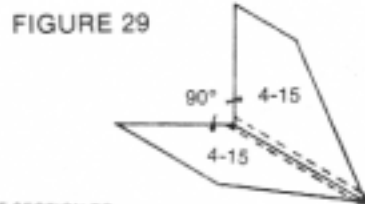
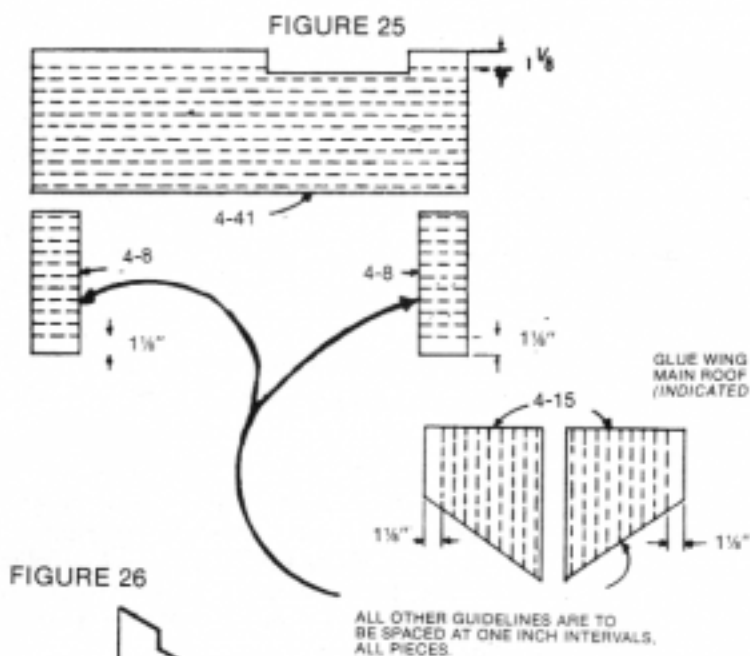
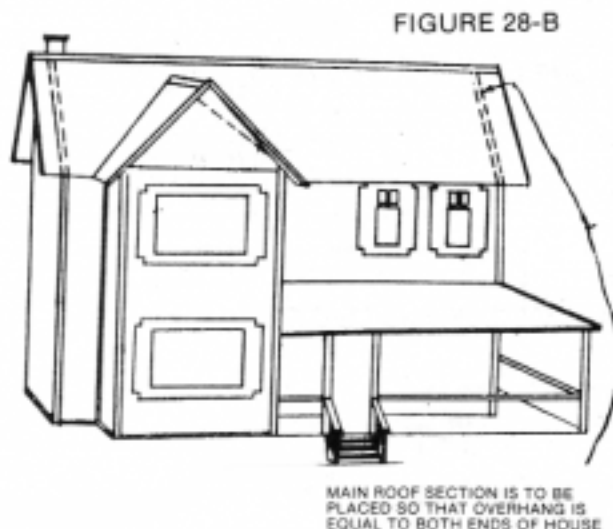

FINAL ASSEMBLY PART 4 PARTITIONS

1. Prepare your tools and materials. You will need the following items to complete this phase:
a dispenser of wood-working glue
a sharp utility knife or a coping saw
a ruler or tape measure
a pencil
a small square
2. Locate the parts. You will need the following parts and completed subassemblies:
4-4, attic partition..... 1 piece
4-35, room partitions..... 4 pieces
5-3, universal mold stock.....
5-41, partition trim 8 pieces
5-48, attic partition trim 1 piece
3. Glue two pieces partition trim (part no. 5-41) on opposite edges of each of the room partitions (part no. 4-35) as shown in Figure 32.
4. Attach attic partition trim (part no. 5-48) as shown in Figure 32.
5. Figures 33-A, 33-B and 33-C show the proper locations of the room partitions. Measure and mark the locations, top and bottom to ensure that the partitions are installed straight and vertical.
6. In numerical order, apply glue to the top and bottoms of the partitions and install them in the positions marked. Use a small square to verify that the walls are exactly vertical.
7. Cut and fit universal molding (part no. 5-3) to use as base molding on each partition.

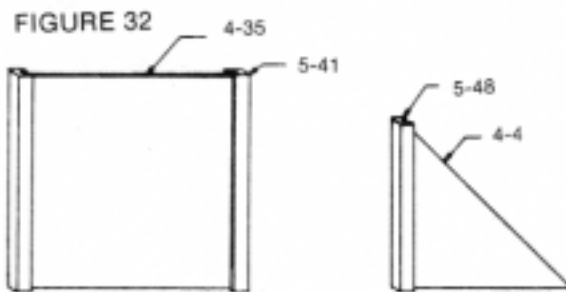

FIGURE 33-A

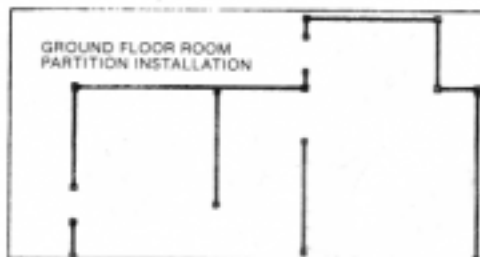

FIGURE 33-B

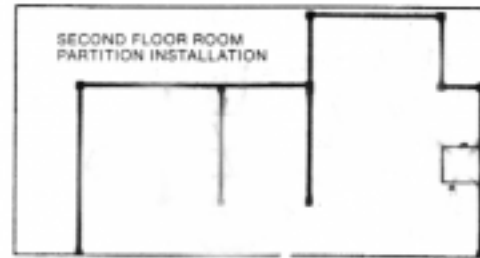

FIGURE 33-C

FINAL ASSEMBLY PART 5 DOORS AND STAIRWAYS

1. Prepare your tools and materials. You will need the following items to complete this phase:
a dispenser of wood-working glue
masking tape
100 grade (med.) sand paper
a sharp utility knife
2. Locate the parts. You will need the following parts and completed subassemblies:
2-5, door top casing 4 pieces
2-7, decorative emblems 12 pieces
2-26, door 2 pieces
5-3, universal molding stock.....
hinge pins (brads) 4 pieces
door knobs (map pins) 2 pieces
stairway subassemblies 1 piece
3½" railing subassemblies 2 pieces
3. Review the instructions and verify that all steps have been completed.
4. Prefit the stairway subassemblies into the house. If the partition trim prevents the stairway from fitting tightly against the partition, cut a notch out of the side of the stairway to provide the necessary clearance. Sand off any glue or other protrusions that interfere with the fit of the stairways.
5. Apply glue to the edges of the stairway assembly that attaches to the partition, and across the top and bottom of the assembly where it contacts the stairwell and floor.

6. Place the stairway assembly in position, taking care to keep glue from getting on the hardwood floor except where the stairway attaches.
7. Once the stairway glue has set, install the stair railing subassemblies as shown in Figure 34.
8. Lay out the decorative emblems (part no. 2-7) on the doors (part no. 2-26) in a pattern that creates an effect you like. (The standard pattern is shown in Figure 35.) Glue them in place.
9. Cut four pieces of universal molding (part no. 5-3) to fit in the tops and bottoms of the two doorways.
10. If the glue is dry from step 8, use sandpaper to round off the hinged edge of the door as shown in the detail circle.
11. Drive a hinge pin through each of the four pieces of universal molding $\frac{1}{8}$ " from one end.
12. Hold the piece of universal molding with the hinge pin through it so that the hinge pin goes into the door $\frac{1}{4}$ " from the rounded edge as shown in Figure 35. Install the four pieces on the tops and bottoms of both doors in this manner.
13. Install the door knob pins as shown.
14. At the top and bottom of each door, insert several paper shims between the door and the universal molding. This will ensure that the door will have proper clearance for opening and closing.
15. Apply glue to the universal molding pieces, then insert the door assembly into the door opening. Be sure the door has adequate clearance at the sides.
16. After the glue has dried, remove the paper shims.
17. Cut pieces of universal molding stock (part no. 5-3) and install it as base molding along the room partitions and around the second floor walls.

FIGURE 34

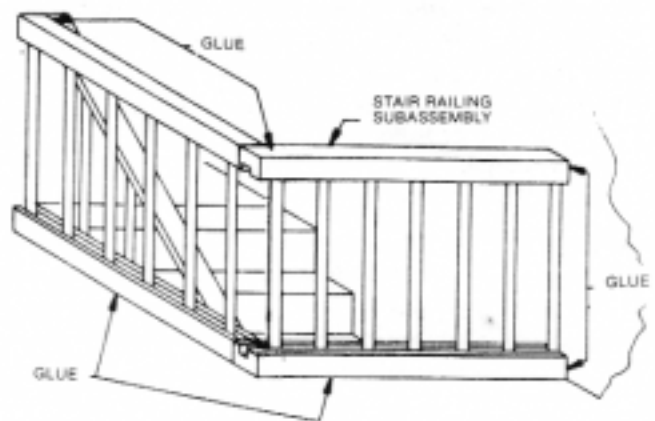
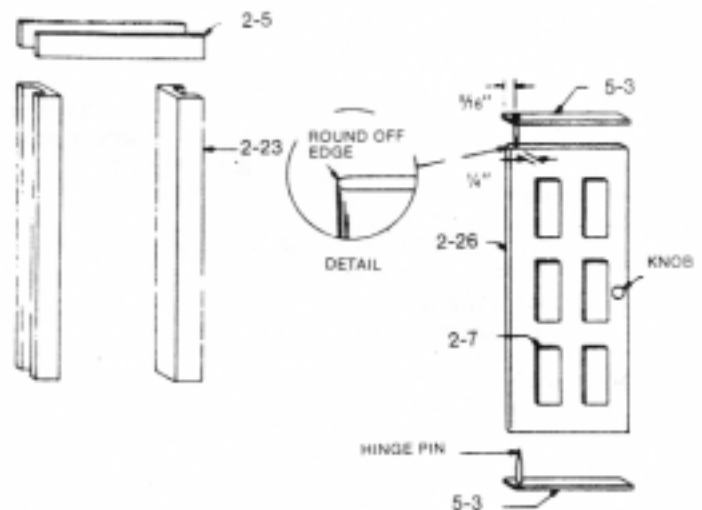

FIGURE 35



**FINAL ASSEMBLY PART 6
LATTICE TRIM**

1. Prepare your tools and materials. You will need the following items to complete this phase:
 a dispenser of wood-working glue
 a sharp utility knife
 100 grade (med.) sand paper
 masking tape
 a ruler or tape measure
2. Locate the parts. You will need the following parts and completed subassemblies:
 2-40, lattice trim 1 package
 5-3, universal molding
3. Trim universal molding (part no. 5-3) to length and glue on **EDGE** around the perimeter of the base as shown in Figure 36. Use masking tape to hold the trim in place while the glue dries. The top of the molding must be flush with the top edge of the base.
4. When the glue from step 3 has dried, start attaching lattice trim to the base as shown in Figure 37-A and Figure 37-B. On each piece, one of the mitered ends will fit flush against the bottom of the molding (part no. 5-3) attached in step 3 and the other mitered end will fit flush to the bottom of the base. Use a piece of the lattice (*without glue*) as a spacer between each of the glued pieces. Start at any corner on the bottom edge of the base and work to the left as shown in Figure 37-B.
5. Complete the bottom layer of lattice work on all exterior sides of the base marked by the arrows.
6. When the glue from steps 4 and 5 has dried, use the same procedure to attach the outside layer of lattice work. Please note that the second layer is running the opposite direction of the first layer.

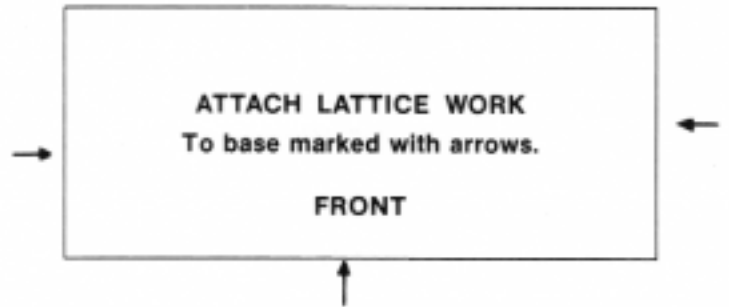

FIGURE 36

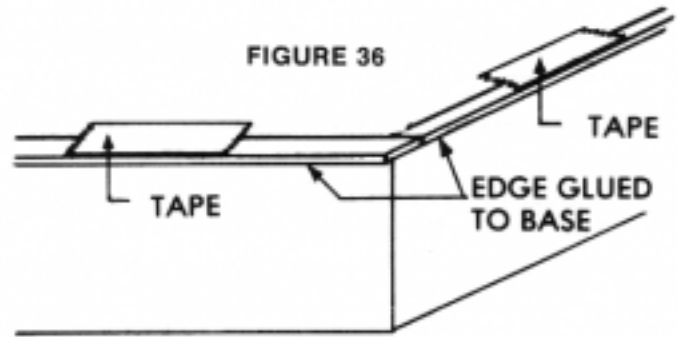

FIGURE 37-A

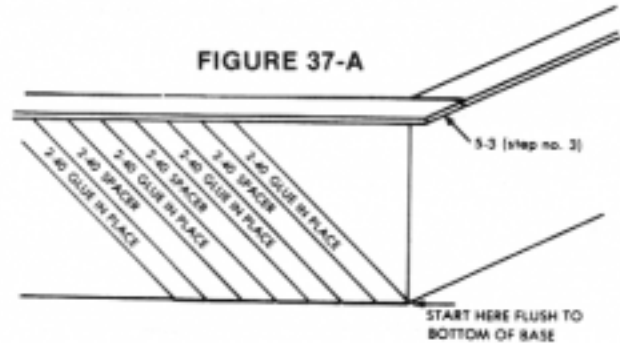
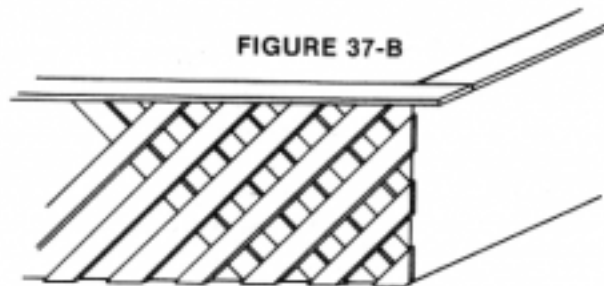

FIGURE 37-B



CONGRATULATIONS!!!!

Your house is fully assembled.

PARTS LIST FH-500

1-2, Siding 14"	11 pieces
1-3, Siding 8 1/4"	10 pieces
1-4, Siding 3"	21 pieces
1-5, Siding 2 3/4"	4 pieces
1-6, Siding 5 1/2"	20 pieces
1-9, Siding 1 1/4"	8 pieces
1-11, Siding 2"	24 pieces
1-14, Siding 8 1/2"	3 pieces
1-16, Siding 18 1/2"	6 pieces
1-17, Siding 11"	6 pieces
1-28, Siding 9 1/2"	6 pieces

SIDING

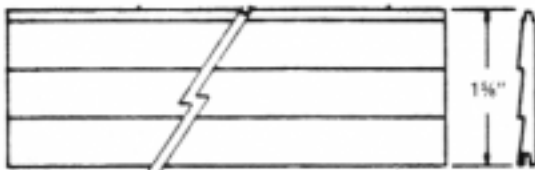

2-5 TOP AND BOTTOM WINDOW CASING
TOP DOOR CASING 27 PIECES

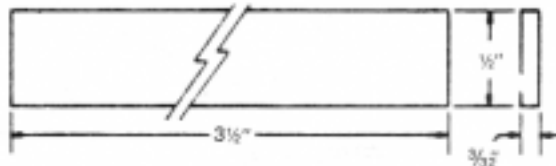

2-6 SHUTTERS 18 PIECES

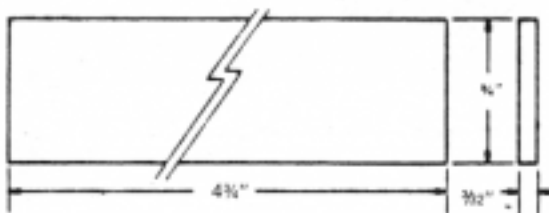

2-7 DECORATIVE EMBLEMS 48 PIECES

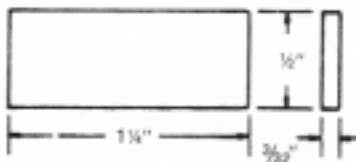

2-22 WINDOW SIDE CASINGS 18 PIECES



2-23 DOOR SIDE CASINGS 4 PIECES



2-26 DOOR 2 PIECES

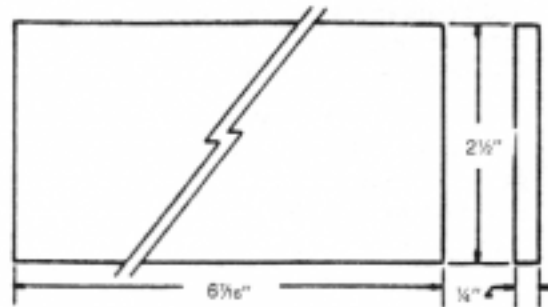

2-29 INSIDE WINDOW TRIM 18 PIECES

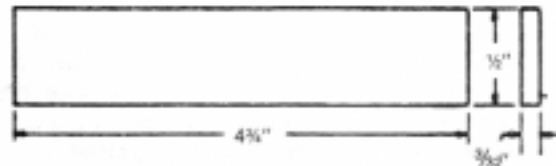

2-30 TOP AND BOTTOM WINDOW FRAME 14 PIECES

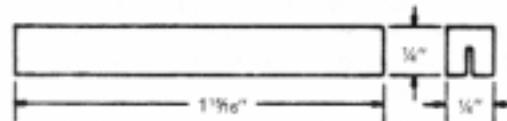

2-31 LARGE WINDOW TOP AND BOTTOM FRAME 4 PIECES

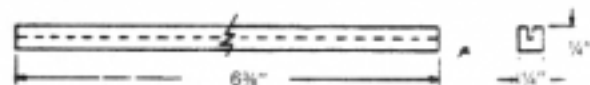

2-32 LARGE WINDOW TOP AND BOTTOM TRIM 8 PIECES

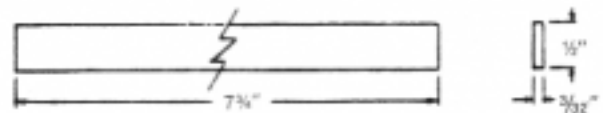

2-40 DECORATIVE LATTICE TRIM

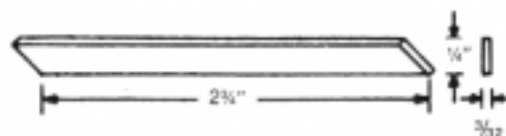

3-2 BASE

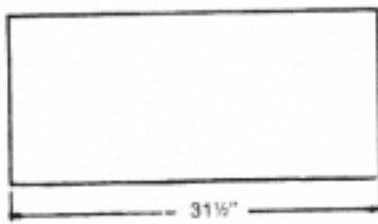

1 PIECE

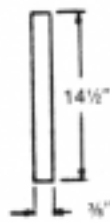

4-15 FRONT WING ROOF

2 PIECES

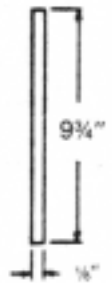
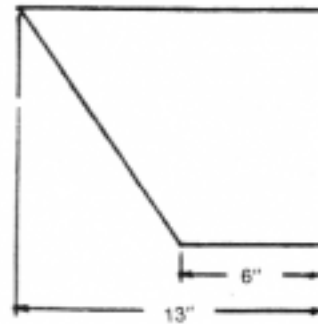

3-3 FRONT BASE

1 PIECE

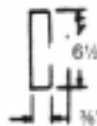
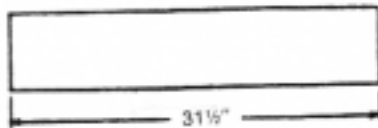

3-6 FOUNDATION STRIP

3 PIECES

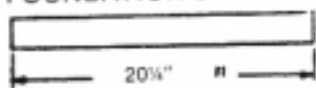

4-17 SIDE PORCH ROOF

1 PIECE

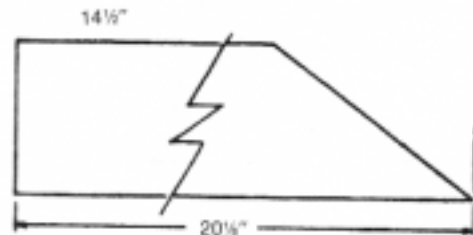

3-10 SIDE BASE

1 PIECE

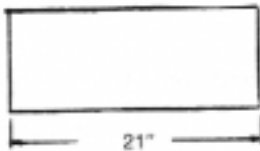

3-11 FOUNDATION STRIP

4 PIECES

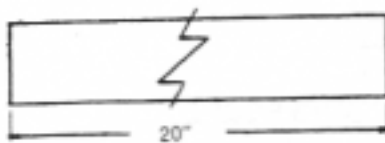

4-35 ROOM PARTITIONS

4 PIECES

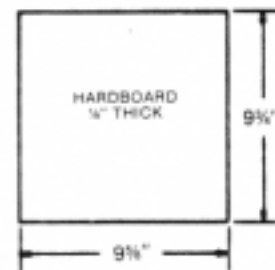

4-4 ATTIC PARTITION

1 PIECE

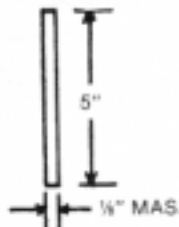
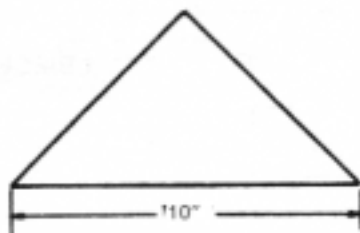

4-36 MAIN GABLE

2 PIECES

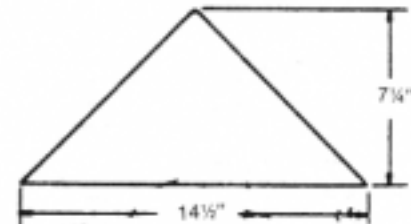

4-8 REAR ROOF PANEL

2 PIECES



4-13 WING GABLE

1 PIECE

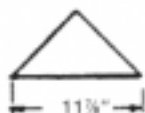

4-37 2nd FLOOR

1 PIECE

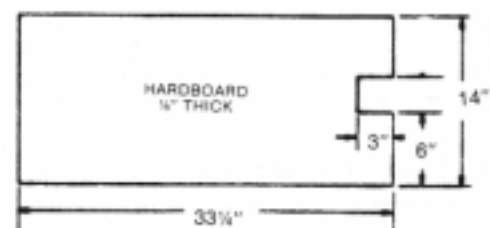

4-38 ATTIC FLOOR

1 PIECE



4-39 FRONT WING FLOOR

1 PIECE



4-40 FRONT PORCH ROOF

1 PIECE



4-41 MAIN ROOF PANEL

1 PIECE

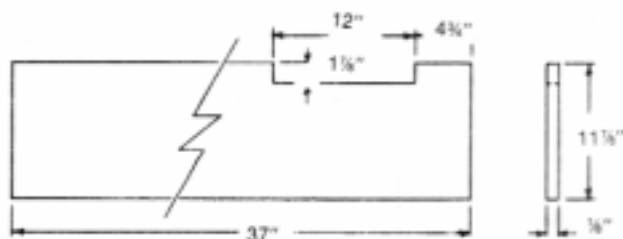

5-1 REAR CORNER POSTS

2 PIECES

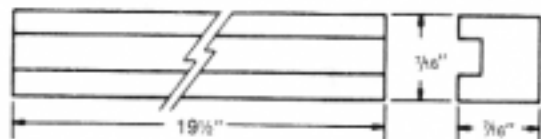

5-2 FRONT CORNER POSTS

6 PIECES

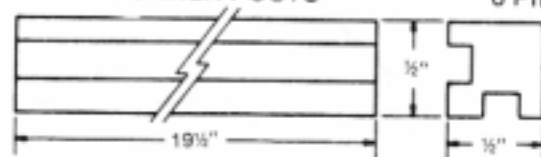

5-3 UNIVERSAL MOLDING STOCK

52 FEET



5-95 FILLET MOLDING

1 PIECE

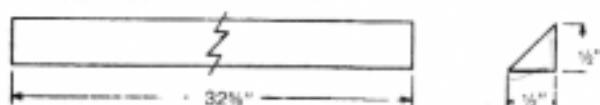

5-150 SHAKES (plain)

1 PACKAGE

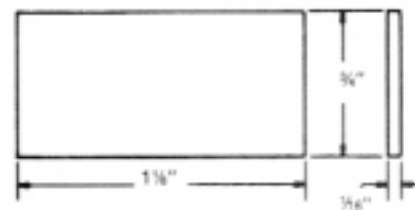

5-70 BANNISTER STOCK

3 FEET

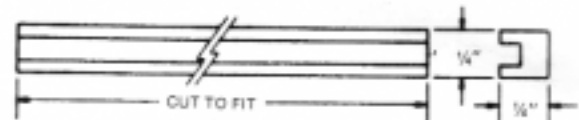

5-151 SHAKES (fancy)

1 PACKAGE

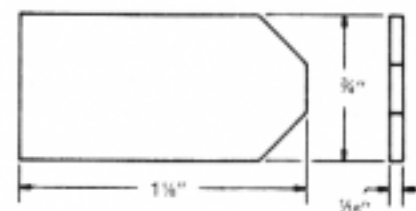

5-19 UNIVERSAL SHAKE TRIM

9 FEET



5-22 FRONT WING ROOF RIDGE CAP

1 PIECE

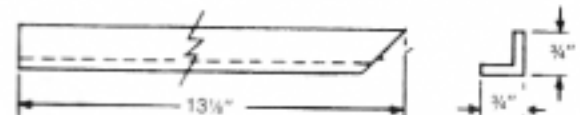

5-24 SIDE PORCH ROOF SUPPORT

1 PIECE

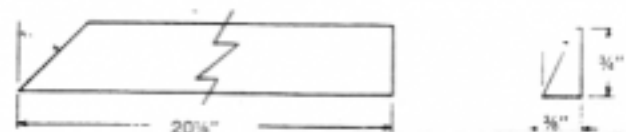

5-25 PORCH ROOF SUPPORTS

5 PIECES

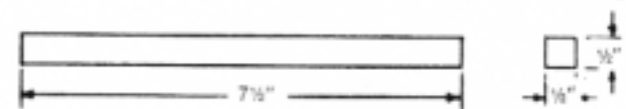

5-26 CHIMNEY STACK

1 PIECE



5-28 CHIMNEY TOP



1 PIECE

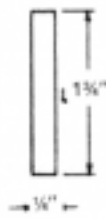

5-41 PARTITION TRIM

8 PIECES



5-46 FLOOR SUPPORT

5 PIECES



5-47 MAIN GABLE SUPPORT

4 PIECES

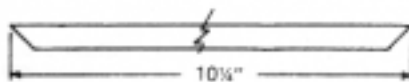

5-48 ATTIC PARTITION TRIM

1 PIECE

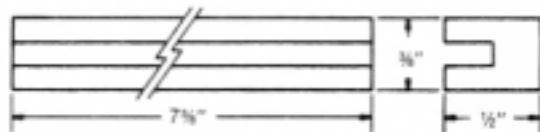

5-49 WINDOW DIVIDER STOCK

12 FEET



5-50 FRONT GABLE SUPPORT

2 PIECES

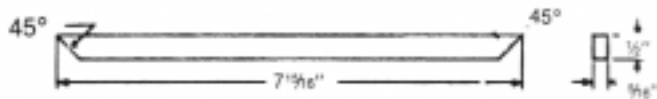

5-51 REAR FLOOR TRIM

2 PIECES

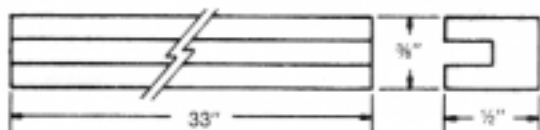

5-52 FRONT PORCH ROOF SUPPORT

1 PIECE



5-53 MAIN ROOF RIDGE CAP

1 PIECE

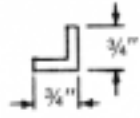
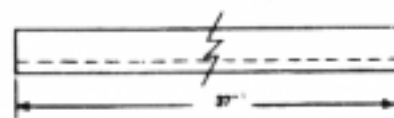

6-2 BANNISTER POSTS

30 PIECES

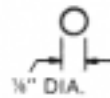
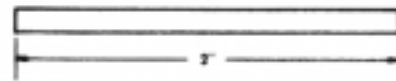

6-4 PORCH RAILING STOCK

8 FEET



6-6 PORCH RAILING POSTS

40 PIECES

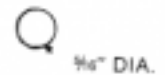
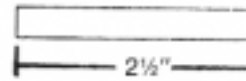

6-7 PORCH STEP, LOWER

1 PIECE

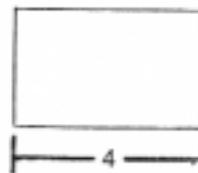

6-8 PORCH STEP, UPPER

1 PIECE

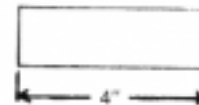

6-12 DECORATIVE GUSSETS

6 PIECES

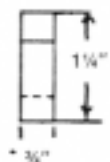

6-13 STAIRWAY BASE

1 PIECE



6-14 STEPS

13 PIECES

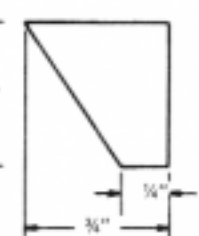
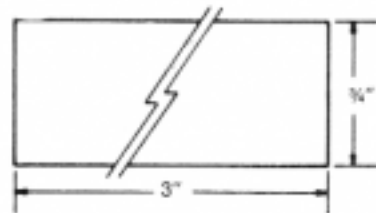

6-17 DOOR KNOB

2 PIECES

6-18 HINGE PINS (1/2" brads)

4 PIECES

6-19 HARDWOOD FLOORING

1 PACKAGE

6-20 WINDOW PANE 2 3/8" x 4 7/8"

7 PIECES

6-23 WINDOW PANE 4 7/8" x 6 3/8"

2 PIECES