

Linfield

LN 190 MINIATURE HOUSE KIT
ASSEMBLY INSTRUCTIONS



FINISHED SIZE: 28"H x 25 1/2"W x 18 1/2"D

SCALE: 1"=1'

*Dura-Craft, Inc.*TM

P. O. Box 459
Newberg, OR 97132

Linfield

LN 190 MINIATURE HOUSE KIT

Assembly Instructions

Congratulations on selecting a miniature house kit manufactured by Dura-Craft, Inc., the leader in the industry. We pride ourselves in our high quality and workmanship. Each piece is graded and sorted at several different stages to ensure that you receive the finest quality.

A Dura-Craft miniature house is a complete kit. You will not have to make separate purchases of items like the windows and shingles which are a basic part of your house.

If ample time and care are used in construction and finishing, your house will be of heirloom quality, of which you will be justly proud.

NOTE: For shortages or broken parts write directly to Dura-Craft, Inc. for replacement, using the form on the last page of this manual.

READ BEFORE STARTING ASSEMBLY:

The following tips will help you avoid problems when you build your miniature house.

1. **Save The Box** - The photo will be very helpful during assembly.
2. **Read Instructions First** - Before beginning construction of your miniature, read through all instructions to get a feel for the assembly process and to gain familiarity with the parts.
3. **Follow Instructions In Order**
4. **Don't Force Pieces** - If you cannot release a part from its board with moderate pressure, carefully cut it loose with a utility knife. Always cut from the good side of the board where the cut lines are clearly visible.
5. **We Will Replace Parts** - If any parts are missing or damaged, Dura-Craft, Inc. will quickly replace them at your request. Please write or call and give us the name and sheet number of the part or parts that you need. We have included a "Missing and Broken Parts Replacement Form" to assist you. It may save time to make missing or broken parts from scrap material.
6. **Use Tacky Glue** - This glue helps hold parts in place while it dries and it dries clear. It can be found at most craft supply stores. Any white household glue or woodworking glue may be substituted if desired. Wipe away excess glue while it is still fresh.

7. **Each Part Is Important** - Dura-Craft, Inc. has done everything possible to ensure that your kit will look good when it is complete. We have included pine moldings to strengthen the house and trim to cover all of the outside wall and floor edges, and we have designed the kit so that slot and tab positions will be hidden when the kit is finished. However, the final quality of your house will depend to some extent on the care you take in preparing each piece for assembly. Sanding is optional, but it will improve your house. It will also remove splinters from the edges of the parts which will help the parts fit better.

8. **Materials List** - You will need the following materials to assist you in the assembly of your miniature house:

- Glue (see paragraph 6 above)
- Utility knife or sharp, sturdy knife
- Masking tape
- Damp cloth or paper towels
- Ruler or tape measure
- Fine toothed saw such as a coping or hacksaw
- Pencil
- Medium and fine sandpaper
- Wax paper
- Several large books to use as weights
- A framing square
- Contact cement (neoprene)
- Steel wool (for hardwood flooring)
- Varnish
- Paint (latex)
- Glue stick- for wallpaper and carpet

GLOSSARY:

Good Side: The side the pieces were stamped from; the smoothest side.

Bead of Glue: A line of glue approximately the size of a pencil lead.

": Inches

Flush: When the edges of two boards are even.

Left and Right Sides: All references will be made from the front view, unless otherwise instructed.

Tab: A projection off the edge of a board.

Slot: A hole in a board that a tab fits into.

Notch: The same as a slot except it's on the edge of a board.

Glass: Silkscreened plastic sheets.

LN190 Window Glass

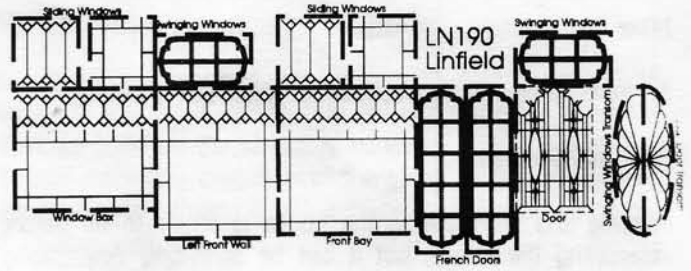

Parts List:

Part No. LN Sheet-1 thru 19
19 stamped sheets of parts
(see back of instructions)

Part No. 7-4
8 oz. Stone Mix

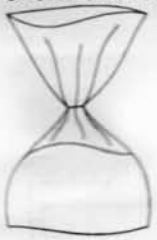

Part No. 7-3
63" Stone Tape

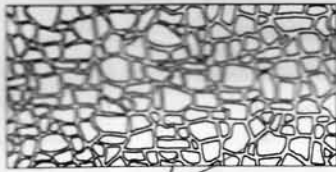

Part No. 5-49

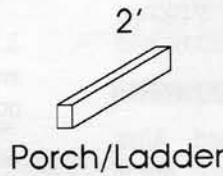

Porch/Ladder

Part No. 5-159
7 1/4"

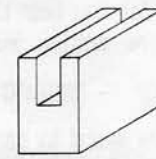

Porch Post

Part No. 8-2
19"

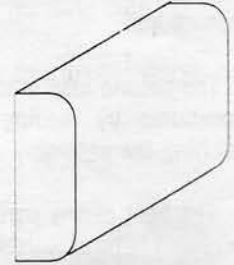

Miter Box

Part No. 5-142
1'6"

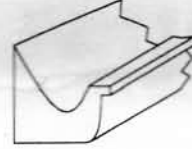

Gutters

Part No. 5-143
3'6"



Downspout

Part No. 5-155
29'

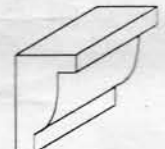

Small Bracket Longframe

Part No. 6-17
4 pc.



Door Knobs

Part No. S5-76
8'

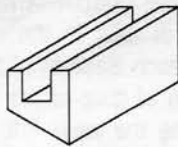

Small Tower Corner Post

Part No. 5-70
18'

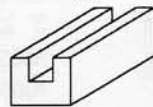

Small Edge Trim

Part No. S5-2
7'6"

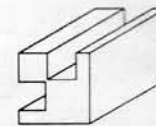

Small Corner Post

Part No. 6-19
1 bundle

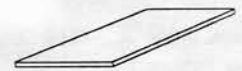

Hardwood Flooring

Part No. 5-3
20'

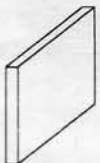

Universal Trim

Part No. 5-46
7'6"

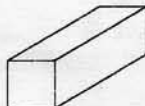

1/4"x1/4"

Part No. 5-150
1 package



Plain Shakes

Part No. 5-156
2'

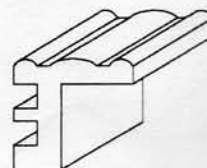

Moving Window Molding

Part No. 5-157



Door Molding

Part No. 5-158
1'6"



Window Trim

LN 190 ASSEMBLY INSTRUCTIONS

Miter Box

1. Refer to back of instructions for Miter Box assembly.

Paint and Wallpaper

Painting and wallpapering the house is easier to do before assembling the house, but it can be confusing determining which parts go where.

1. The first step is to label each part on the dieboards using a pen, tape and the dieboard illustrations at the back of the instructions.

2. The second step is to become familiar with the construction procedures by reading the entire written instructions and watching the assembly video.

3. The best gluing surface is bare wood to bare wood. After becoming familiar with the house, you can accurately plan which surfaces to paint which color and which inside walls will be part of the same room. Wallpapering will be addressed more completely later in the instructions.

4. When painting and papering, be sure to leave space on the edges of the walls (approximately 1/8") bare to fit into the grooves of the cornerposts. The walls and posts fit together snugly without paint. With paint and wallpaper, the posts may split.

BASE

1. Locate the Base Floor Back, Base Floor Front, Left and Right Base Floor Splices, Front to Back and Side to Side Base Floor Supports, Bay Base Wall, Front Base Wall, Back Base Wall, Left Base Wall, and Right Base Wall (Die cut Sheets LN 190-1,2,3,4).

2. Lay Base Floor Front and Back on a flat surface with the **good sides up**. Tape both parts together along the junction line. See Figure 1.

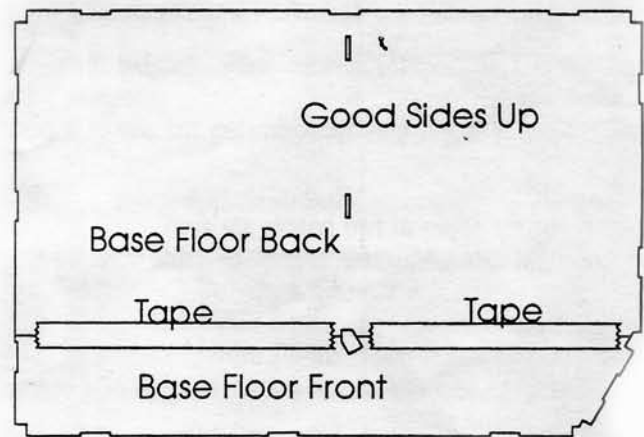

Figure 1

3. Turn the Base Floor Assembly over so that the **Good sides are down** and glue the Left and Right Base Floor Splices into position. See Figure 2.

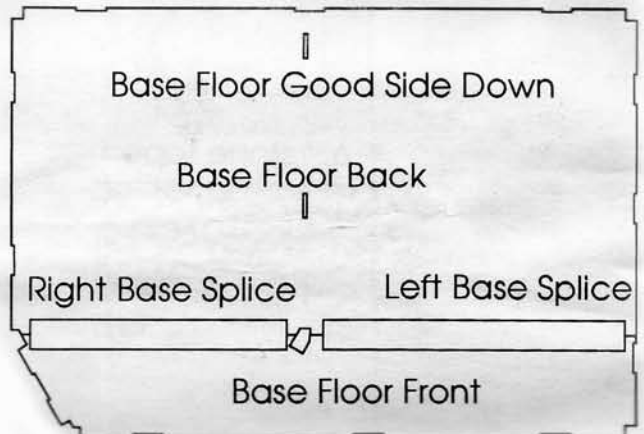

Figure 2

4. With the Base Floor Assembly still good side down, apply a 3" long piece of tape to the under side of the floor at each notch. Glue each Base Wall to the Base Floor Assembly by running a bead of glue to the tabbed edges of the Base Walls and interlocking the walls into the notches of the Base Floor assembly. Glue and tape the Base Floor Supports into place. Do not glue the ends of the Base Walls together at the corners, cornerposts will be inserted there. See Figure 3.

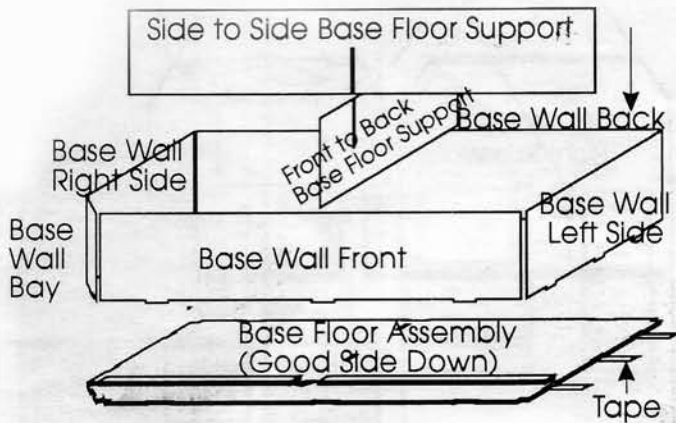

Figure 3

STONEMORTAR

1. Paint the Base Walls with latex paint. This paint will become the mortar lines between the bricks. Black, white and grey are popular colors.
2. Peel the Stencil Webbing from the Stone Pattern Stencil Tape at about a 45° angle as in Figure 4. Stick the Stencil to the bottom edge of the Base Walls leaving enough overhang of the ends of the walls to hold onto for removal. Press firmly for full contact. Mask the Base Walls above the Stone Stencil with masking tape. This will prevent the Stone Mix from adhering to the area where the 5-155 trim will be glued later.

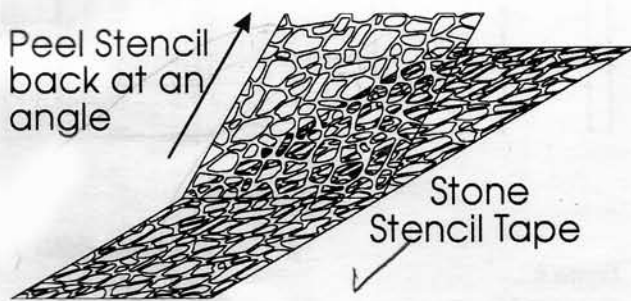

Figure 4

3. Put about 3 tablespoons of tacky glue (or other white glue) into a paper cup, add an equal amount of water to the glue. Mix well.
4. To cover 1 foot of Stone Stencil it takes about 1 1/2 ounces or 1 3/4 tablespoons of Stone Powder. Put the appropriate amount of Stone Powder for the length of surface to be covered into an empty cup. Slowly add small amounts of glue mixture to the Stone Powder (it is easy to add too much liquid). Mix after each addition. Continue until the mixture holds its own

shape like cake frosting. If it is too wet, it may seep under the stencil.

5. Spread mix over one wall with a putty knife to about 1/16" thick. If you would like to alter the appearance of the stone, then do it before the stencil is removed. Some suggestions include sprinkling pepper over the stone to give it a granite appearance or painting it with a diluted paint/water mix to give it an aged look.

6. Remove the stencil within 5 minutes. Stick a scrap piece of wood to the overhanging stencil end and pull as when removing the stencil from the original backing. The wood handle will help remove the stencil evenly. Remove the masking tape.

7. If needed, touch up the stones with a pencil while the stones are still soft.

HARDWOOD FLOORING

1. Locate the Hardwood Flooring (Part 6-19). The Hardwood Flooring Bundle contains enough hardwood strips to cover only one floor of the house. This material may alternatively be applied to the door, stairways, or used as wall paneling, but not all. **Do not use water based glue for flooring because it will cause the hardwood strips to curl.**

WARNING: Oil based contact cement is extremely volatile and flammable. The working area must be well ventilated. Keep away from flame or sparks. We recommend the use of Neoprene based contact cement (by Elmer'sTM) which is water clean-up and has very low fumes.

2. Brush contact cement on the Base Floor and one side of the Hardwood Strips. Let dry. Follow the instructions on the contact cement.

3. Start laying hardwood strips at the back of the house and work toward the front. Cut the strips with scissors to the desired length. Off-set the joints so that the ends of the strips land randomly over the surface of the floor.

4. After the Hardwood Strips are in place, burnish them down by rubbing them firmly with a wood block or the back side of a spoon.

5. To achieve a pegged appearance, punch the ends of each strip with a 3/32" nail set or the flattened end of a nail. See Figure 5.

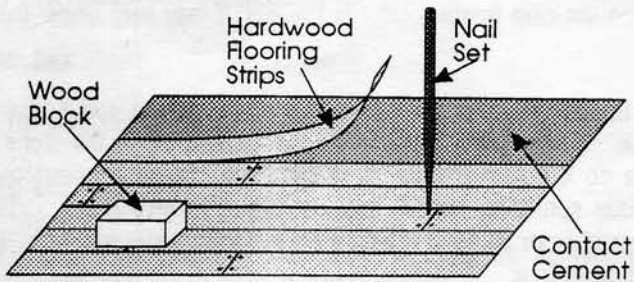

Figure 5

6. Sand the flooring smooth and remove any traces of contact cement that would interfere with the varnish.

7. Varnish the floor. We recommend the use of VARATHANE™ brand, water clean-up varnish. It has low fumes and is non-toxic. Follow the manufacturers instructions. It is better to apply several thin coats, rather than one thick coat.

8. Cut Slots- Because the 1st Floor Room Partition bottom tabs and the cornerposts at the right side of the Left Front Wall will protrude through the Base Floor, the Hardwood Flooring must have holes trimmed in it. To accomplish this, lay the base floor assembly with the hardwood surface face down on a flat surface that won't be harmed by scratches. Using a utility or X-acto knife, trim the hardwood flooring that can be seen through the Base Floor slots and anchor hole. Sometimes the slots can become wider than required. The finished width of the slots should be 1/8". Leave 1/8" of hardwood flooring around the anchor hole opening. This hole was purposely made slightly larger than needed to accommodate subtle cornerpost variances. When actually installing the anchoring post, the hardwood flooring can be accurately trimmed to fit.

WALLS

1. Gather Left Side Wall, Left Front Wall, Right Front Top and Bottom Walls, Right Side Wall, Bay Left and Right Top and Bottom Walls, Left and Right Overhang Walls (Sheets- 7,8,9,10).

2. Floor Supports- Lay the walls shown in Figure 6 **good side down** and draw lines for the Floor Supports. Measuring from the bottom edges of the walls, these lines should be at 8 1/2" for the 2nd Floor and 17 1/2" For the 3rd Floor Supports. This should be at the same level as the bottoms of the slots in the walls. Cut 5-46 to fit as described in Figure 6. Glue and tape 5-46 in place. The ends of the 5-46 should be 1/4" from the edge of the wall edges. This will allow the walls to be inserted into the corner posts. Let dry. Add Balcony Floor Supports to the good sides of the Right Top Bay Wall and the Left Front Wall at the exact same locations.

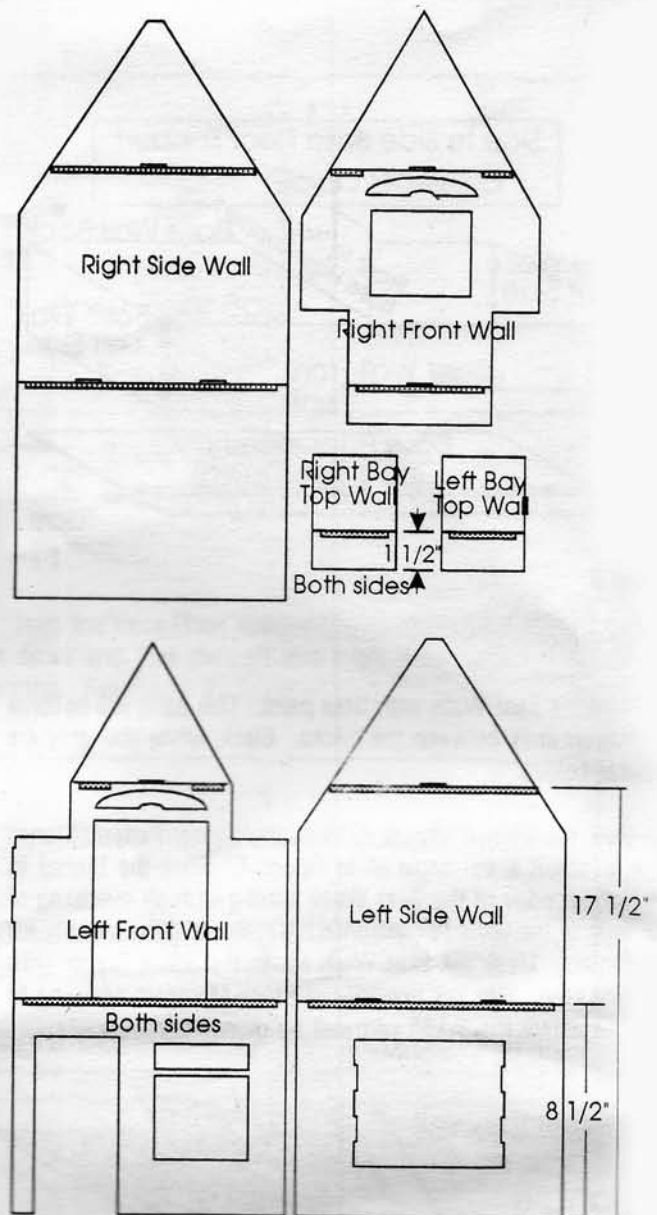

Figure 6

Wallpaper

3. Wallpaper- Look to the back view of the house on the label and Figure 7 for a guide to wallpaper locations. Using a glue stick, glue wallpaper to the . Cover the entire inside (bad side) surface of a wall with glue and stick the wallpaper to it. Using a sharp knife, cut the paper 1/8" in from the edge of the outer edge of the walls. Because of the close tolerances of the molding to fit the wall thickness, the paper may make the wall too thick to fit into the grooves of the posts. Trim the wallpaper away from the window and door openings as in Figure 7.

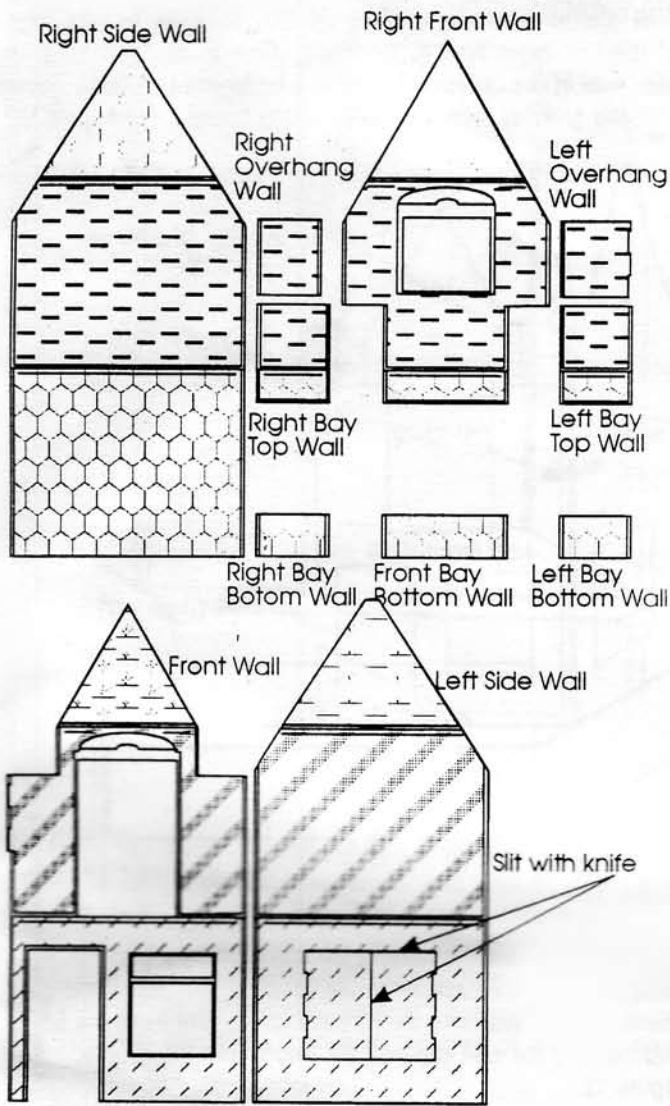

Figure 7

LONGFRAME PRE-ASSEMBLIES

Figure 8 shows the locations of the cornerposts and the walls.

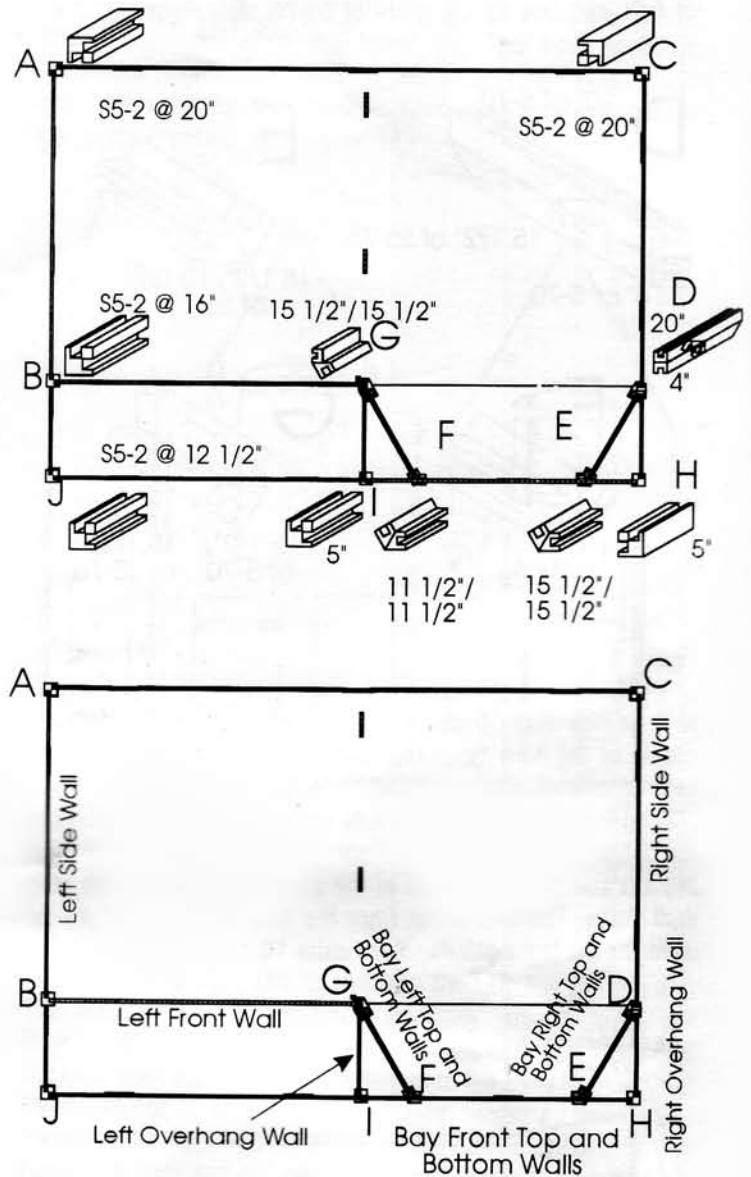

Figure 8

1. Assemble longframe assembly "D" by cutting a 24" piece of 5-70 into a 4" and a 20" piece. Using the 20" piece of 5-70, the 4" piece of 5-70, and one 15 1/2" piece of S5-7, assemble longframe assembly "D" as in Figure 9. Cut the 5-70 from the same stick to reduce waste.

2. Assemble longframe assembly "E" using two 15 1/2" pieces of S5-76. See Figure 9.

3. Assemble longframe assembly "F" using two 11 1/2" pieces

of S5-76. See Figure 9. Cut these from the same 24" stick to reduce waste.

4. Assemble longframe assembly "G" using one 15 1/2" piece of 5-70 and one 15 1/2" piece of S5-76. See Figure 9.

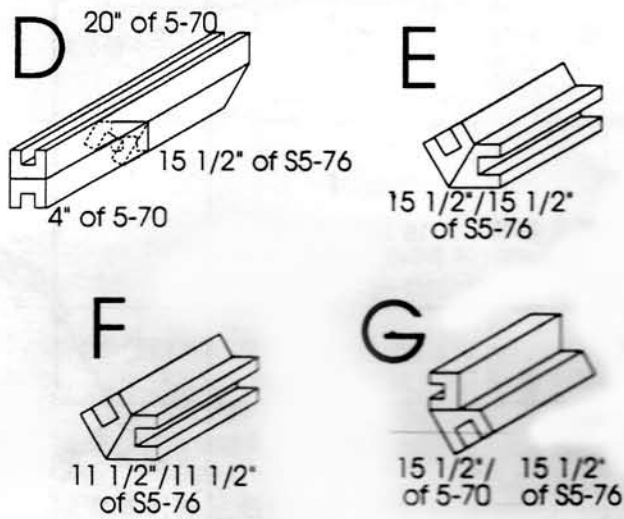

Figure 9

5. Left Side Wall- Install a 24" piece of S5-2 into the left back corner of the base assembly, location "A". Insert and glue the Left Side Wall into the forward facing groove of the S5-2, making sure the wall edge is fully seated into the groove. Glue the bottom edge to the Base Floor. After the glue is dried, trim the top end of the S5-2 off at the same angle as the Left Side Wall Gable. The excess cut from the tops of the posts will be used for the front gables. See Figure 10.

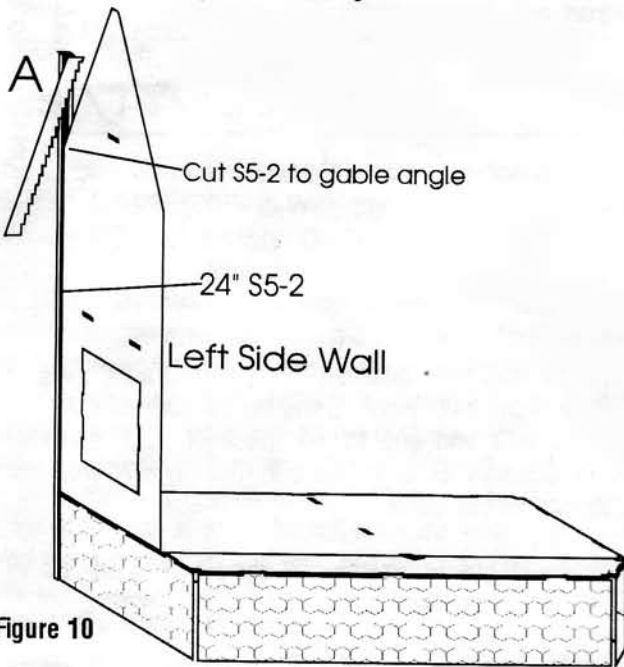

Figure 10

6. Left Front Wall- Glue a 16" length of S5-2 to the forward edge of the Left Side Wall, location "B". Insert the Left Front Wall into the remaining groove. DO NOT GLUE the bottom edge of the Left Front Wall to the floor. Glue a piece of S5-2 to each side of the verticle sections just under the Left Front Gable with the grooves facing the back of the house. See Figure 11.

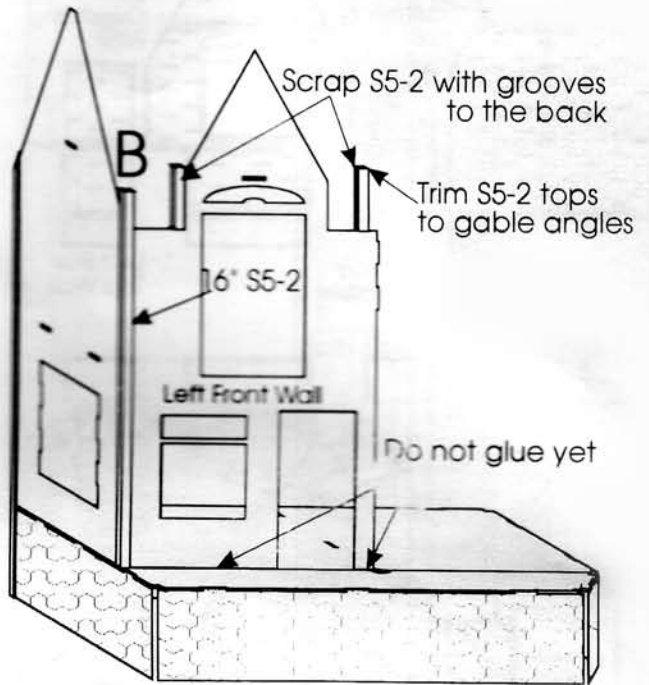

Figure 11

7. Right Side Wall- Install a 24" piece of S5-2 into the right back corner of the base assembly, location "C". Insert and glue the Right Side Wall into the forward facing groove of the S5-2, making sure the wall edge is fully seated into the groove. See Figure 12.

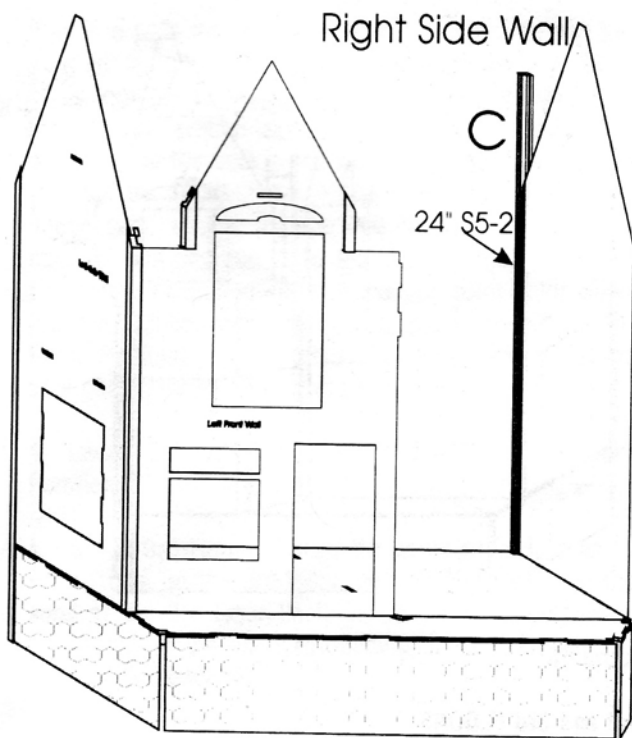

Figure 12

8. Right Bay Walls- Glue longframe assembly "D" into place. Glue 15 1/2" longframe assembly "E" into place by gluing it to the Bay Base and Front Base Wall edges. The top of this longframe assembly should also be 11 1/2" from the top of the Base Floor. Slide the Right Bay Bottom Wall down the grooves of the longframe assemblies. Glue in place. Glue the Right Bay Top Wall into place flush with the tops of the longframe assemblies. See Figure 13.

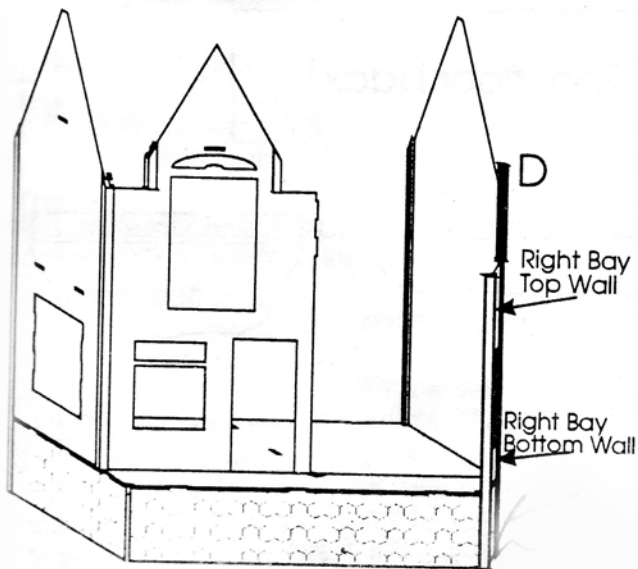

Figure 13

9. Front Bay Walls- Insert and glue the Front Bay Bottom Wall into the bottom of the "E" longframe assembly. Glue F longframe assembly to the left edge of the Front Bay Bottom Wall. Glue and slide the Front Bay Top Wall down the longframe assemblies until it rests on the tops of the assemblies. Make sure all walls have been fully inserted into the posts grooves. See Figure 14.

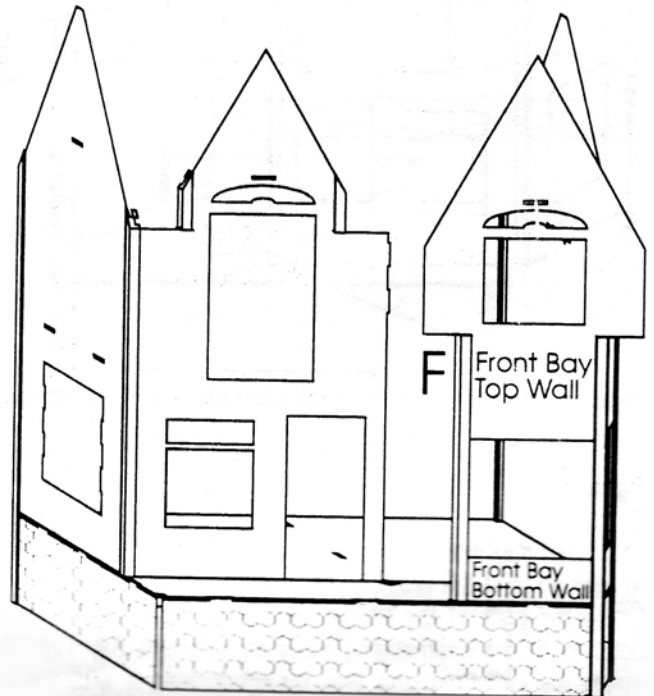
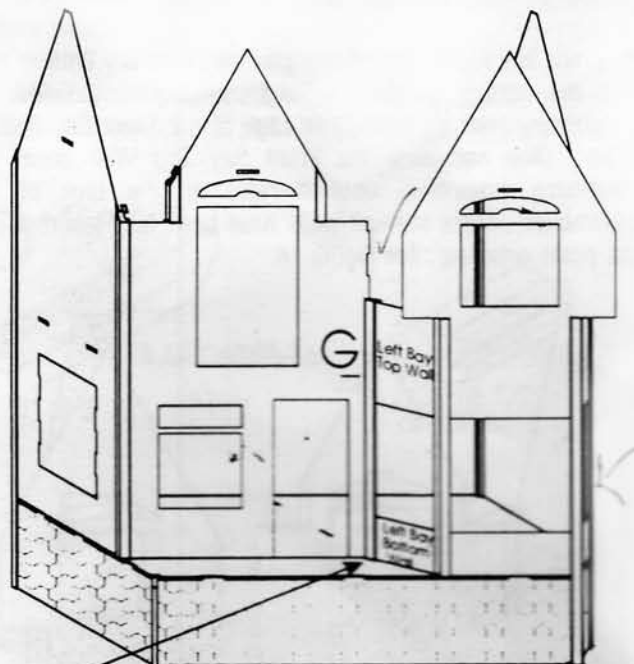

Figure 14

10. Left Bay Walls- Dry fit and tape the Left Bay Bottom and Top Walls into the "F" longframe assembly. Insert the Anchor Post Longframe assembly "G" between the Left Bay Walls and the Left Front Wall and slide it down onto the Base Floor so that the bottom of "G" can be traced onto the hardwood flooring for trimming the flooring to fit. Trace the outline of "G" onto the hardwood floor and cut away the extra flooring from inside the outline with a knife. The Anchor post "G" will rest on the working surface and the top of "G" should be 11 1/2" from the top of the Base Floor. Glue all of the dry fit parts into position and glue the walls to the Base Floor. also, glue the bottom of "G" under the base floor to the base floor supports. See Figure 15.



Trace bottom of "G" onto Floor, cut hole, insert "G", glue.

Figure 15

11. Overhang Walls- Glue a 4" scrap piece of S5-2 (H and I) to each edge of the Front Bay Top Wall with the empty grooves facing the back of the house and the bottoms flush with the bottoms of the overhanging sides of the Front Bay Top Wall. Install the Left Overhang Wall by interlocking it with the Left Front Wall and inserting it into the S5-2 just installed on the Front Bay Top Wall and gluing in place. To install the Right Overhang Wall, glue and slide the Right Overhang Wall down the front facing 5-70 groove in the "D" longframe assembly and the S5-2 installed on the right edge of the overhang of the Front Bay Top Wall. See Figure 16.

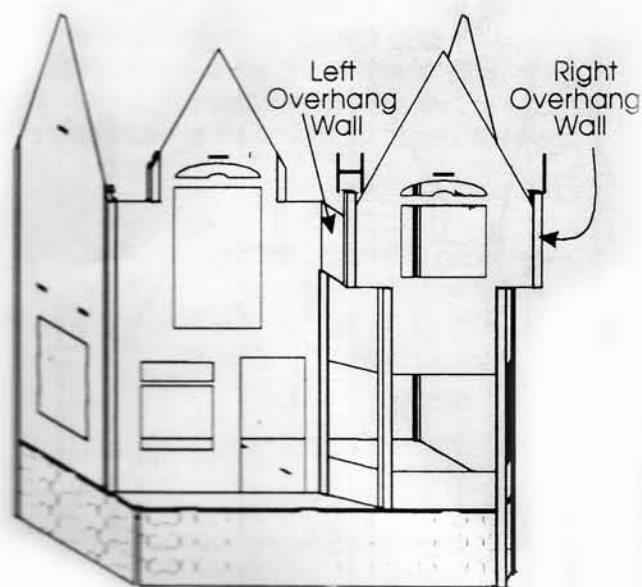

Figure 16

2nd and 3rd FLOORS

1. Locate 2nd Floor Front, Back, Splice, and 1st Floor Room Partition (Sheets- 4,5,17).
2. Splice 2nd Floor- Lay the 2nd Floor Back and Front on the table with the good side up and tape the junction line. Turn the floor assembly over and glue the 2nd Floor Splices in place as in Figure 17.

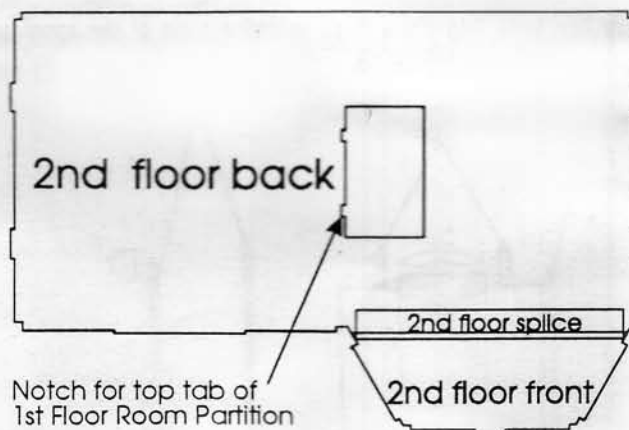

Figure 17

3. Install 2nd Floor- Run a bead of glue on the top of the 2nd Floor Supports (5-46). Set the 2nd Floor on the 2nd Floor Supports and insert the tabs on the edges of the floor into the slots in the walls. Apply tape over each tab on the edges of the

floor and pass the tape through the slots in the wall to secure floor tightly to walls. Tape the back edges of the Left and Right Walls together to keep them from spreading. Dry fit the 1st Floor Room Partition by inserting the tabs on the bottom of the partition into the slots in the Base Floor and sliding the partition towards the front of the house until the tab slots are fully interlocked. Fit the top tab into the notch in the 2nd Floor stairwell opening that is to the front of the house to ensure proper fit and determine wallpaper or paint color orientation. Remove partition and wallpaper or paint. Install the 1st Floor Room Partition. Glue in place. Place weights on the 2nd Floor until glue dries (Cans of paint,books...).

4. Locate 3rd Floor Front, Back, Splice, and 2nd Floor Room Partition (Sheets- 4,6,17).

5. Splice 3rd Floor- Follow the same procedure as the 2nd Floor. Line up the 3rd Floor Front to the marks on the front edge of the 3rd Floor Back. Save the rectangular piece that comes out of the stairwell opening, it can be used as a trap door. See Figure 18.

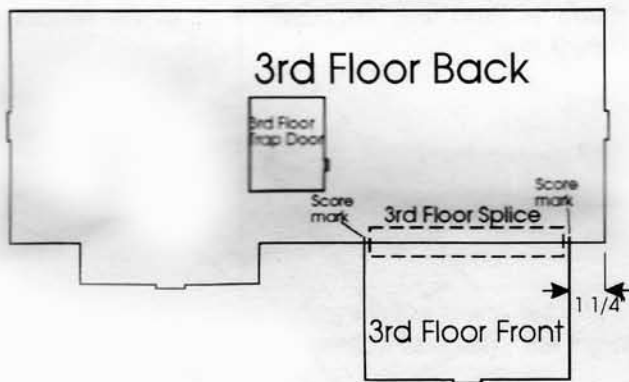

Figure 18

6. Install 3rd Floor and 2nd Floor Room Partition- Follow the same procedure as the 2nd Floor and 1st Floor Room Partition.

7. Add 5-70 to back edges of Floors and Room Partitions edges. See back view on the label.

ROOF

1. Locate Front Roof, Back, Window Box, Balcony, Front Left Gable, and Front Right Gable (Sheets- 11,12,14,15,16,18).

Shake Lines- On all of the roof parts there are scored marks. These are for drawing lines across the roof parts for the top edges of the shakes to line up with. Using a straight edge and a pencil, draw lines across the roof parts. See Figure 19.

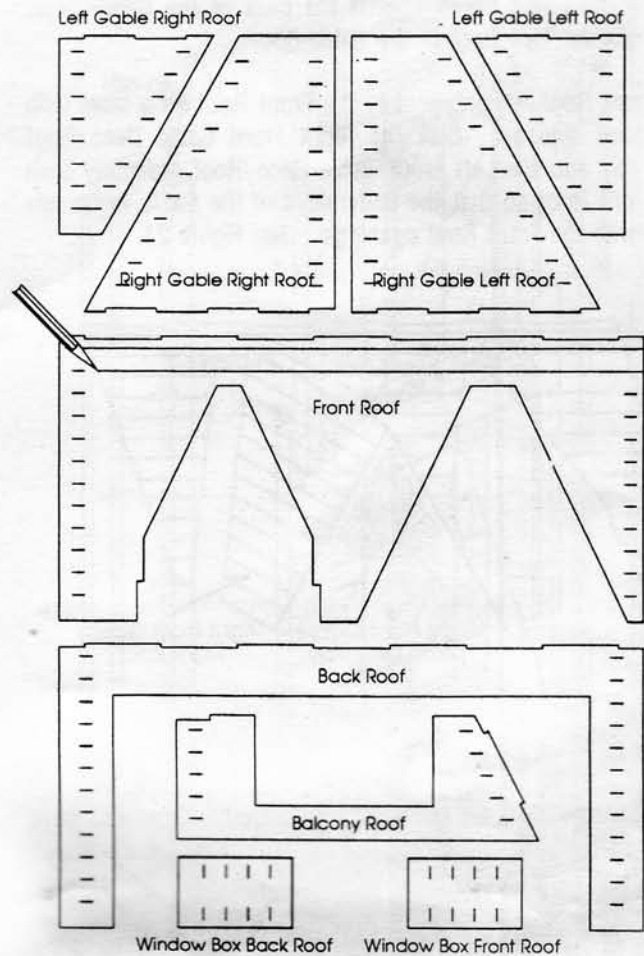

Figure 19

GABLE DECO

1. Locate the Front Right Gable Deco parts (Sheets- 11,14), Front Left Gable parts (Sheets- 9,11,15,19), Left and Right Side Gable Deco Parts (Sheets- 9,10,12,13,19).

1. Assemble Gable Decos as in Figure 20.

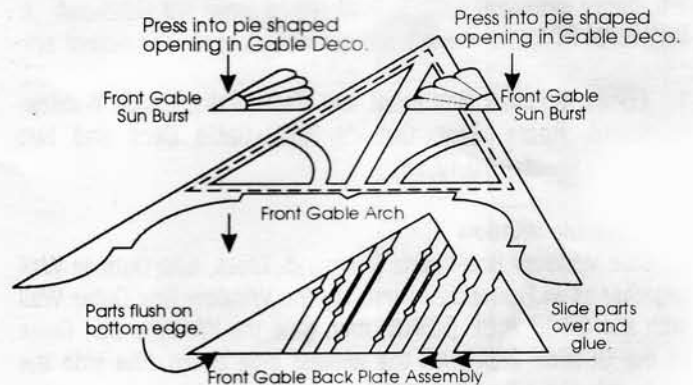

Figure 20

2. Install the Front Left and Front Right Gable Decos. into the Gables Roofs by laying the Gable decos. good side down and sliding the Gable Roofs against the peak of the Gable Deco. Interlock the top edges of the Gable Roofs.

3. Front Roof Assembly- Lay the Front Roof on a table with the good side up. Glue the Right Front Gable Deco./Roof assembly and the Left Front Gable Deco./Roof assembly onto the Front Roof so that the undersides of the Gable Roofs are flush with the Front Roof openings. See Figure 21.

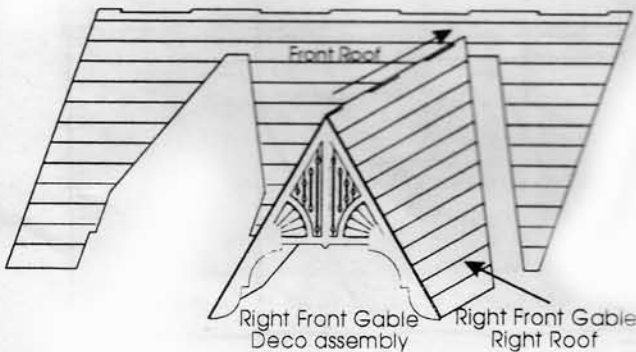

Figure 21

4. Glue the Side Gable Deco. assemblies to the Front and Back Roofs to complete the roof assembly. Interlock the top edges of the Front and Back Roofs.

5. Dry fit the Front Roof Assembly and the Back Roof onto the gables. Tape in place. Dry fit the 3rd Floor Room Partition into place. Draw a line around the inside of the Front Roof assembly along the top of the 3rd Floor and on each side of the 3rd Floor Room Partition. This will be the line used to determine the different rooms for different wallpaper or paint. Apply Wallpaper or paint. Install Roof Assembly and 3rd Floor Room Partition. Install Left Front Gable Side Walls into the small pieces of S5-2 on each side of the Left Front Gable. They should rest on top of the Front Roof.

WINDOW BOX

1. Locate Window Box Front and Back Walls, Inside Window Surround, Roofs, Seat, Outside Wall, Gable Deco and two Brackets (Sheets- 10,12,13).

2. Assemble Window Box-

a. Glue Window Box Inside Surround, Glass, and Outside Wall together as in Figure 22. First, lay the Window Box Outer Wall with the GOOD SIDE DOWN, then glue the Window Box Glass to the Outside Wall with the whitest side down (the side the white ink was silkscreened to).

b. Next, glue the Window Box Inside Frame to the Glass and Wall.

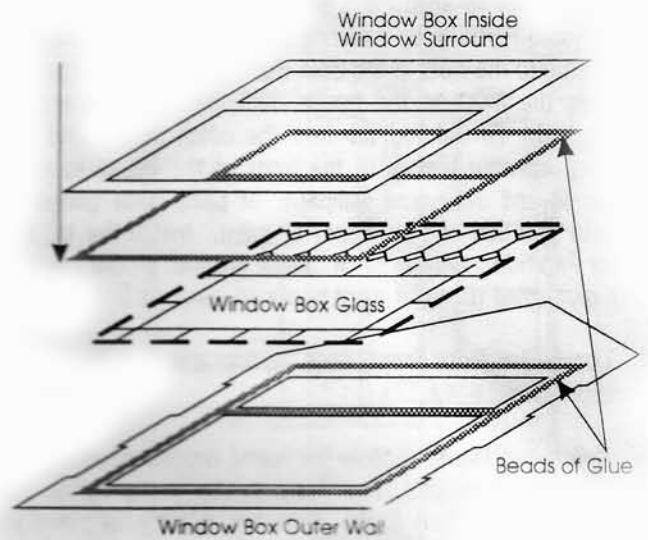

Figure 22

c. Interlock and glue walls into position. Install Seat, Brackets and Roof parts. Figure 23. The Window Box Seat bottom side should be flush with the bottom edge of the Window Box Outside Wall.

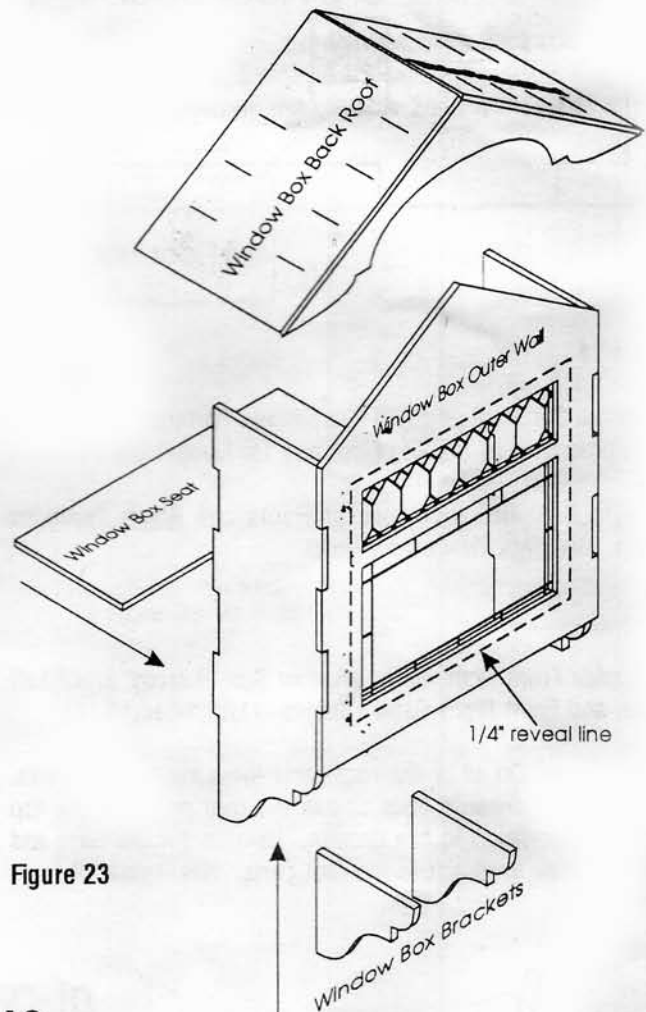

Figure 23

d. Measure and mark 1/4" away from the Window Box window opening. Cut and install 5-155 above and below, and 5-158 to the left and right of the lines as shown in Figure 23.

WINDOWS AND DOORS

1. Locate Bay Sliders, Frames, and Sills (Sheets- 14,18,19,) and Glass.
2. Assemble Bay Working Window Frame/Slider Assemblies as in Figure 24.

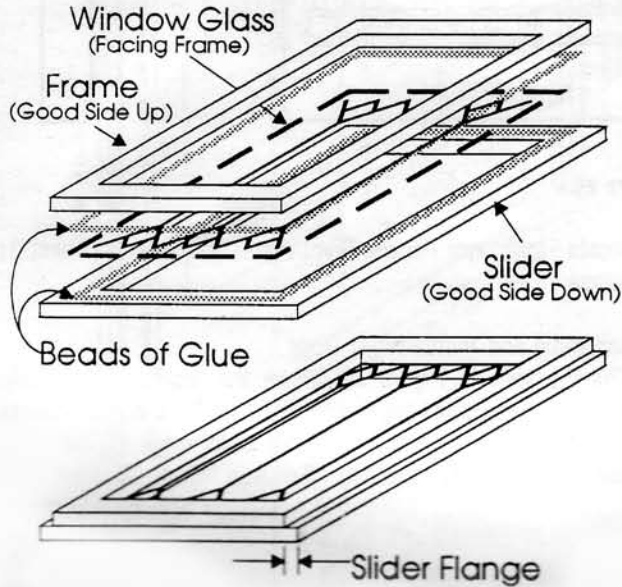

Figure 24

3. Assemble top and bottom sliding window assemblies with 5-156. Install Window Sill. Install window assembly. See Figure 25.

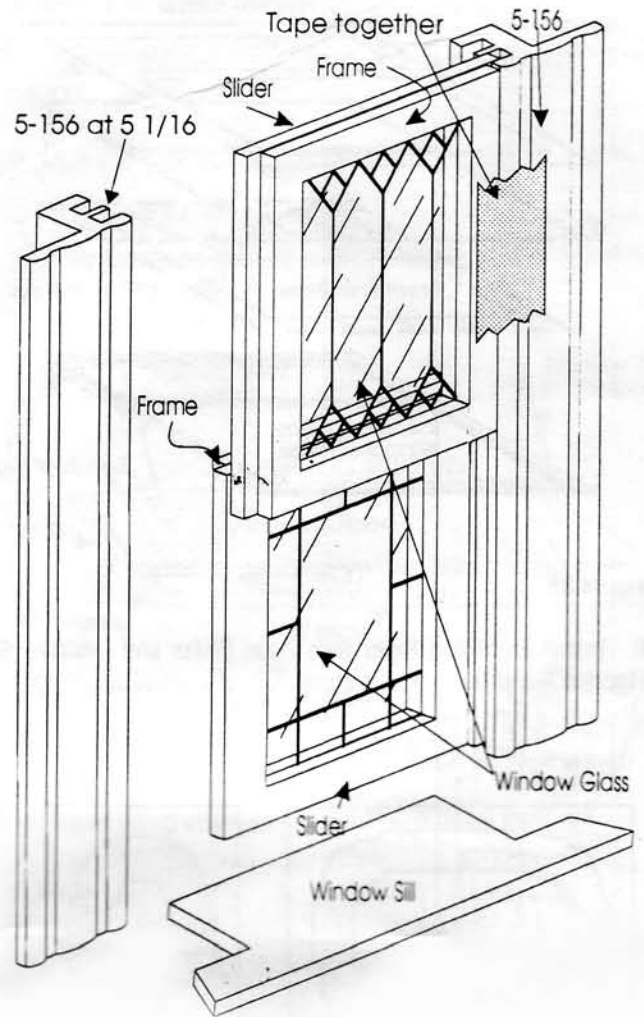

Figure 25

4. Locate Bay Front Inside and Outside Frames and Sill (Sheets- 12,14) and Glass.
5. Install Bay Front Window
 - a. Assemble the same as the Slider/Frame assembly except that the Inside and Outside Frames are the same size. See Figure 26.

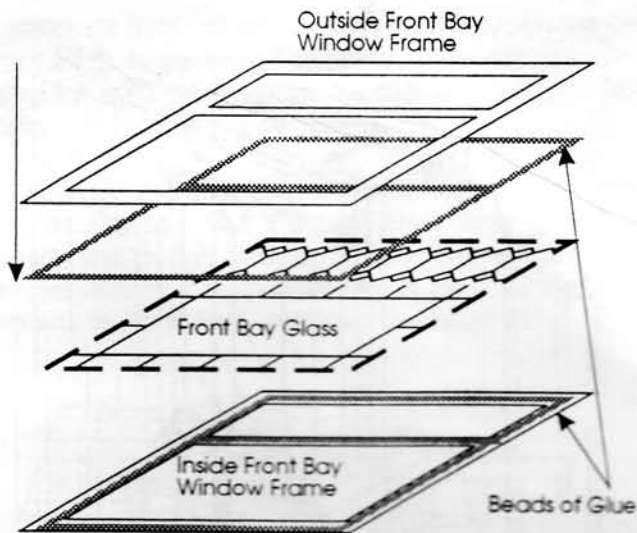

Figure 26

6. Install Front and Right Side Deco Plates and Inserts. See Figure 27 and front label picture.

Center Inserts in Plates.

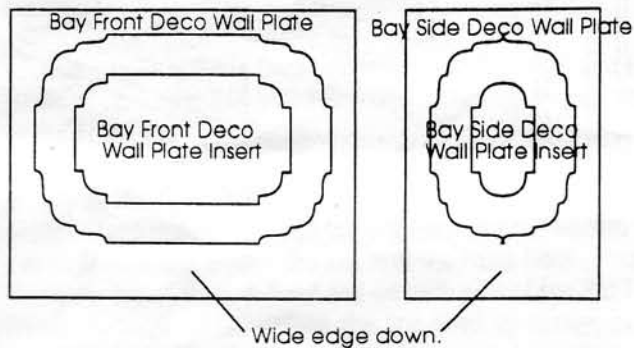

Figure 27

7. Locate Left Front Wall Window Inside Surround (Sheet- 13) and Glass.

8. Wrap and Install Left Front Wall Window

a. Glue the glass to the frame with the ink side away from the frame. Glue Frame/Glass Assembly to the inside of the Left Front Wall.

b. Measure a 1/4" reveal around the outside of the window opening in the Left Front Wall. Cut and glue two 5 1/16" lengths of 5-158 and one 5 1/2" piece of 5-155. See Figure 28.

d. After the Front Door is installed, the top piece of 10 3/4" piece of 5-155 will be installed over the window and the Front Door.

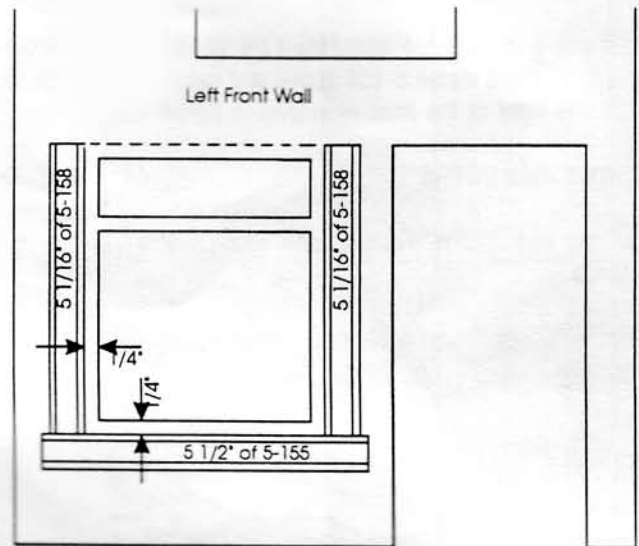

Figure 28

8. Locate Front Door Panels, Pivot Plates and Inserts (Sheet-3) and Glass.

9. Assemble and Install Front Door

a. The top view in Figure 29 shows the Inside and Outside Front Door panels glued together with Front Door Window Glass installed between. It also shows the pivot edge of the door rounded to allow door opening. See also Figure 30.

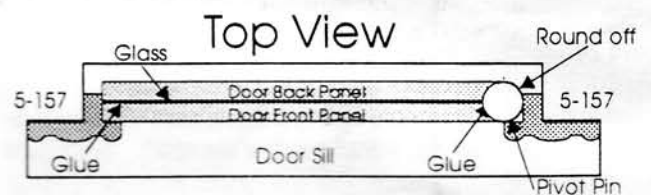

Figure 29

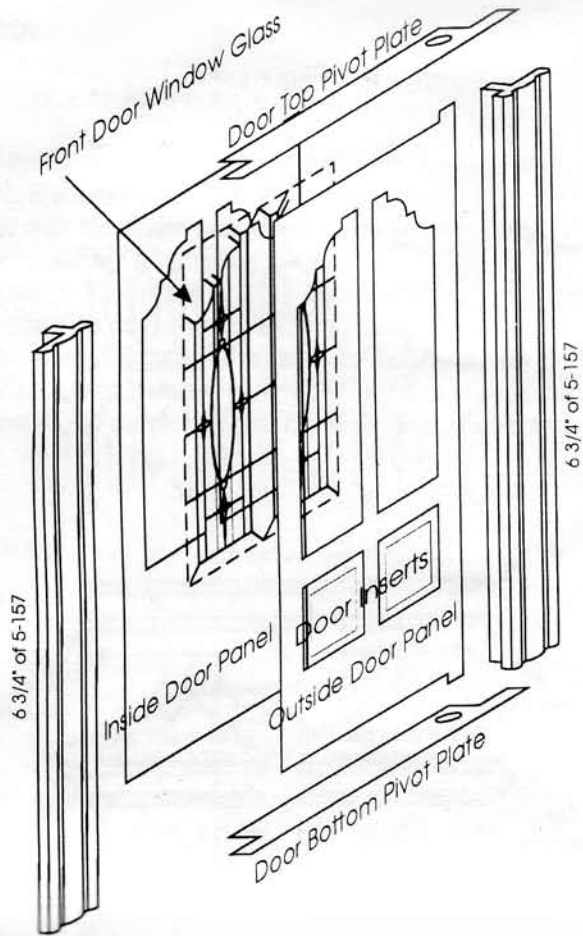

Figure 30

10. Locate Swinging Window Frames, Pivot Plates, Transom Frames (Sheets- 15,16) and Glass.

11. Assemble and Install Swinging Windows as in Figure 31.

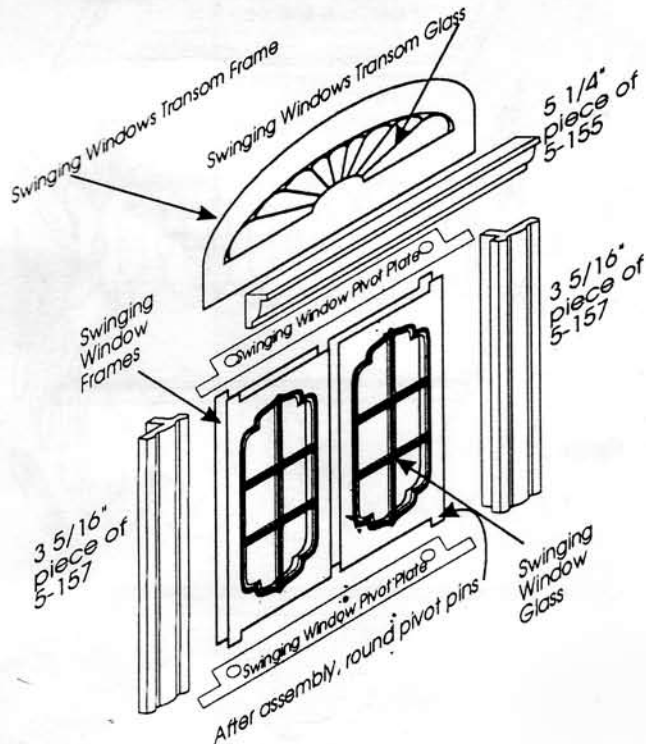

Figure 31

BALCONY AND PORCH

1. Locate Balcony Floor, Roof, and Roof Supports (Sheets- 16,17).
2. Cut and glue S5-76 to edges of Balcony Floor. Figure 32.
3. Install Balcony Roof Supports to the Good Side of the Balcony Floor and the bad side (underside) of Balcony Roof as shown in Figure 32.

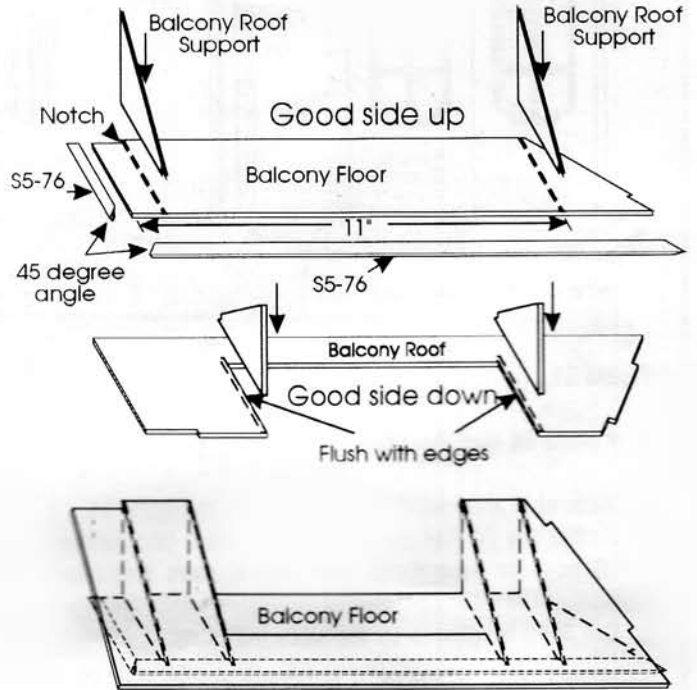

Figure 32

4. Install a 12 1/2" piece of S5-2 at location "J", which is at the front left corner of the porch. Glue the S5-2 to the base walls so that the bottom end is flush with the bottom edge of the base walls.
5. Glue Balcony Floor to the top of the Balcony Floor Supports and the S5-2. Glue the Balcony Roof into place on top of the Balcony Floor. See Front view.
6. Locate French Door Panels, Pivot Plates, Transom Frame (Sheets-15,17) and Glass.
7. Assemble and Install French Doors
 - a. Exactly like Swinging Window. See Figure 33.

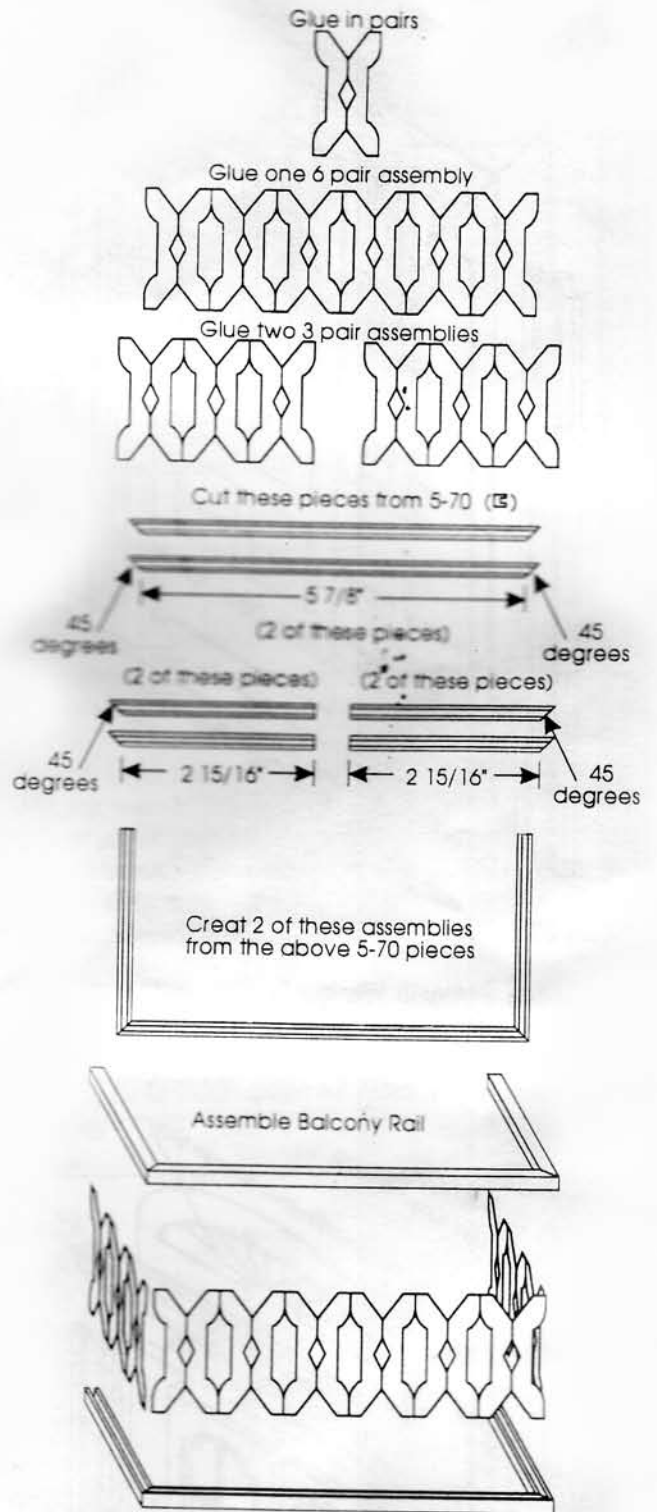
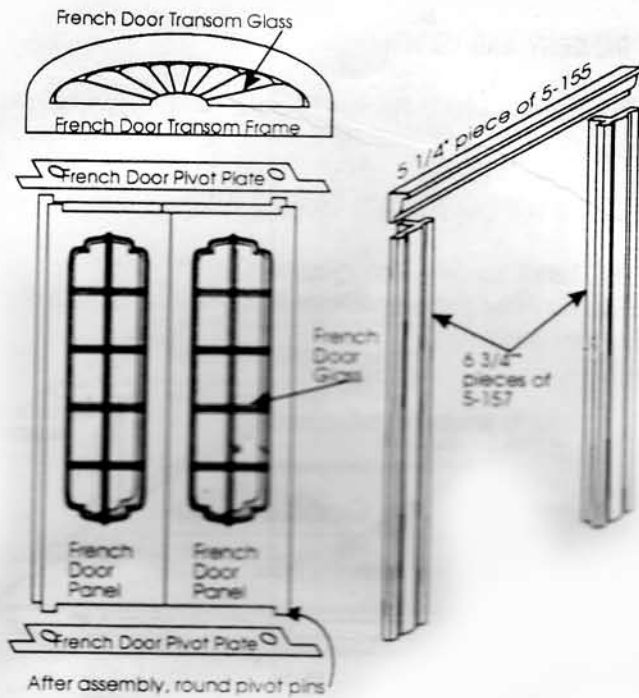

Figure 33

8. Locate 24 Rail Pieces.
9. Assemble and install Balcony Rail as in Figure 34.
 - a. Gather the 24 Rail pieces and glue them into pairs.
 - b. Glue three assemblies, one with 6 pairs and two with 3 pairs.
 - c. Cut 5-70 longframe to the sizes indicated.

Figure 34

PORCH

10. Locate 16 Rail Pieces.
11. Assemble and Install Porch Rails, Porch Header and Install Porch Brackets.
 - a. As with the Balcony Rail, build one 5 pair assembly and one 3 pair assembly from railing pieces.
 - b. From 5-70, cut two 2 15/16" pieces and two 4 3/4" pieces.
 - c. Locate the one piece of 5-159 which is 7 1/4" long.
 - d. Assemble Porch Rails as in Figure 35. Center the 5-70 on the Rail assemblies.
 - e. Install Rail assemblies into cornerposts as shown on label.

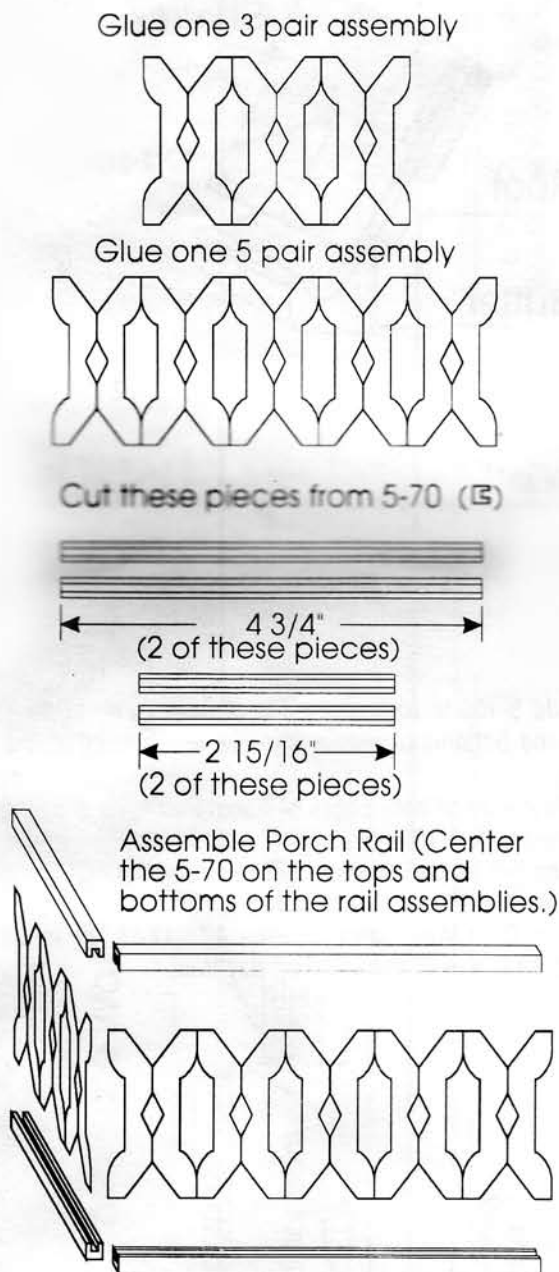

Figure 35

Figure 35

- f. Assemble Porch Header using 5-70, 5-49, and Porch Header Diamond, and Porch Brackets (Sheets- 5,17) as shown in Figure 36.

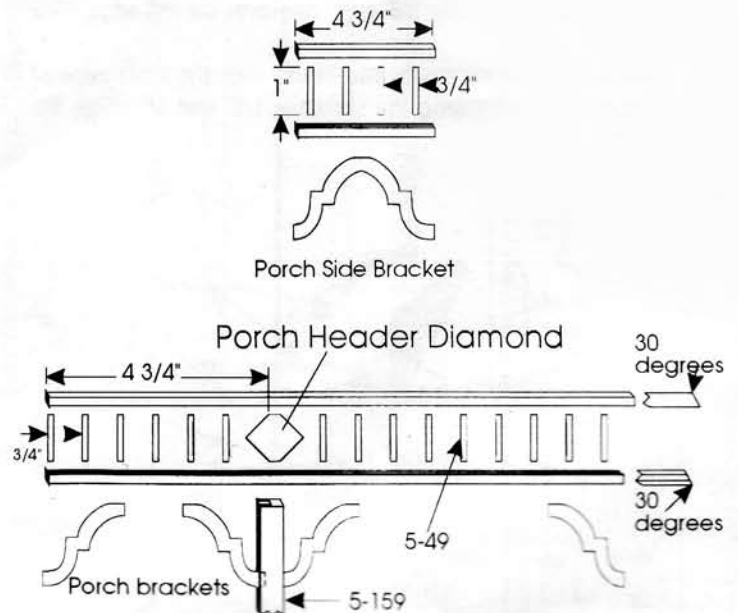

Figure 36

FRONT STEPS

1. Locate Front Step Supports, Risers, and Treads (Sheets- 6,7,8).
2. Assemble and Install Front Steps as in Figure 37.

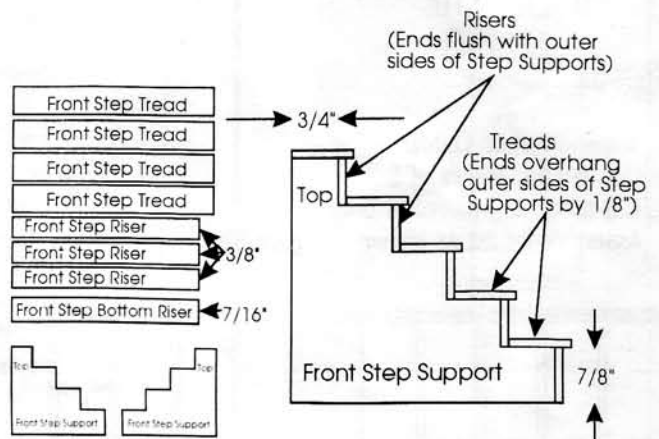

Figure 37

STAIRCASE

1. Locate Staircase Supports, Risers, and Treads (Sheets- 4,5,6,8,19).
2. Assemble and Install Staircase.
 - a. Set the two Staircase Supports on the longest flat edge with the point in the corner of a drawer. Glue Risers in place. Glue Treads in position leaving 1/8" overhang over the left edge. See Figure 38.
 - c. Install Staircase assembly into house with the front edge of the 2nd Floor overhanging the staircase 1/8" and acting as the top step.

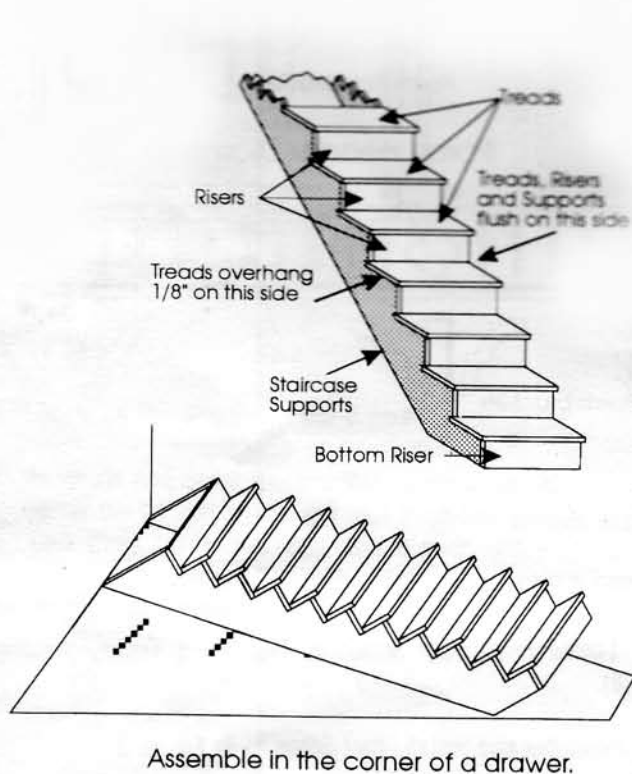

Figure 38

2. Assemble Attic Ladder.
 - a. Cut two 11" pieces of 5-70.
 - b. Cut ten 1 3/4" pieces of 5-49.
 - c. Assemble ladder as shown in Figure 39.

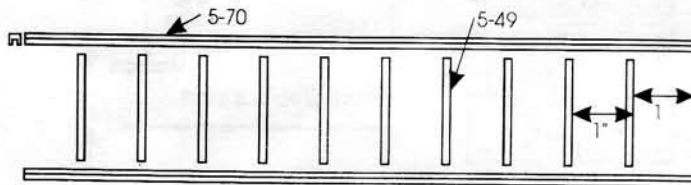

Figure 39

SHAKES AND GUTTERS

1. Shake Roof
 - a. Using the lines drawn earlier on the Roof parts, glue a row of shakes starting at the bottom. When gluing the second row of shakes, off-set the row 1/2 a width of a shake so that the center of the shake is over the junction of the two shakes below. See Figure 40.

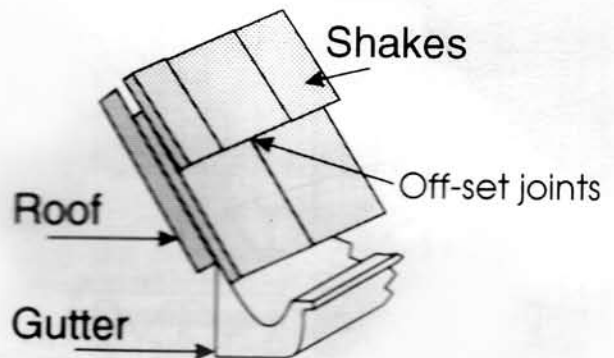

Figure 40

2. Assemble and Install Gutters and Downspouts. See Figure 40 and front view on label.

TRIM

1. Add 5-155 to roof edges, top of Base, to cover floor slots, tops and bottoms of windows inside, and bottom of Overhang Walls.
2. Make sure all back edges of Room Partitions and Floors are trimmed with 5-70.
3. Add 5-3 to the insides of windows and doors. Use 5-3 for baseboard in all rooms and porch.
4. Add Deco Wall Plates (Sheets- 4,13,17,18,19) to Left and Right Walls and to the Left Top Bay Wall.



Sheet LN-1

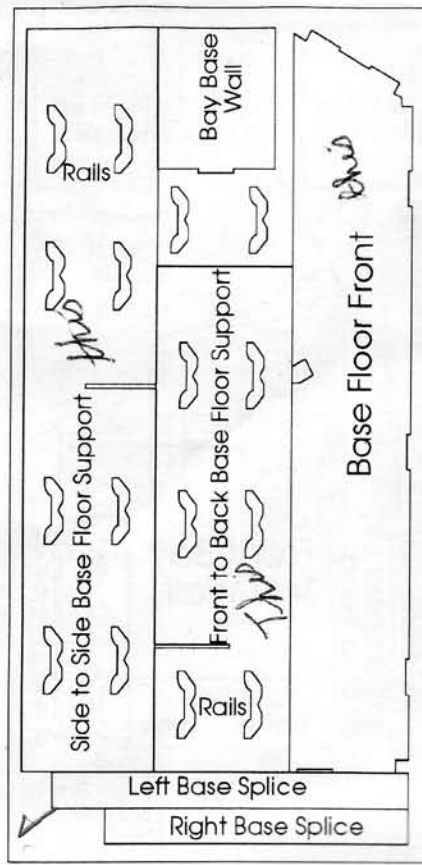

Sheet LN-2

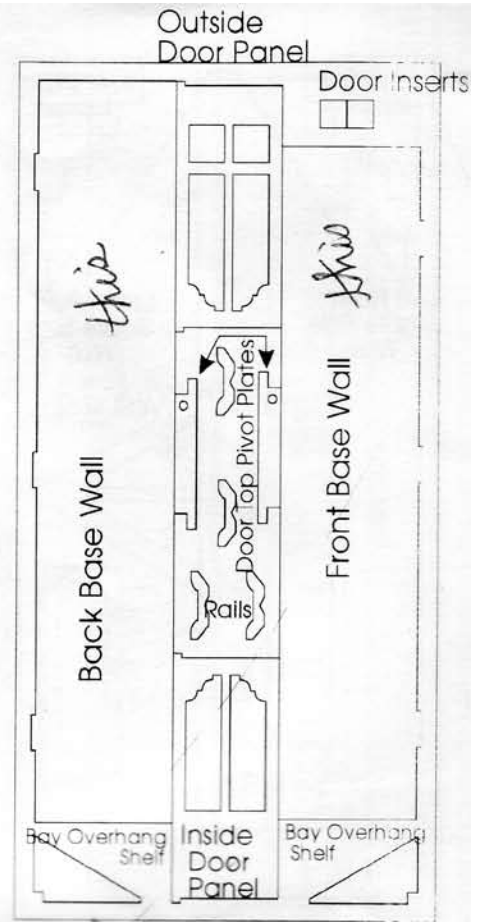

Sheet LN-3

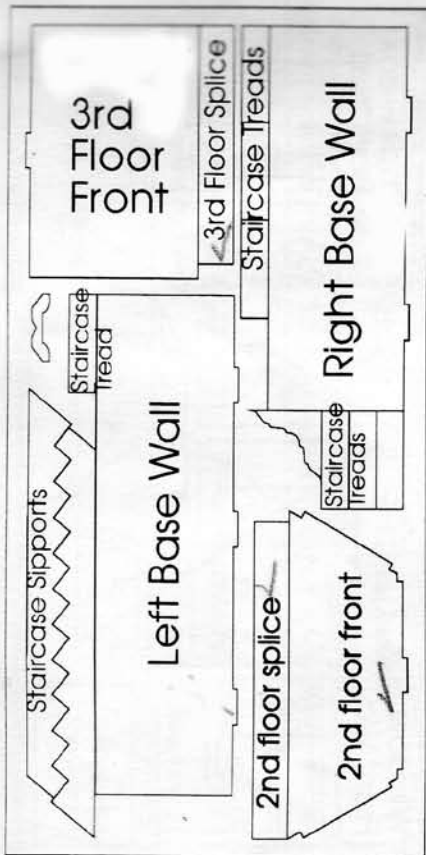

Sheet LN-4

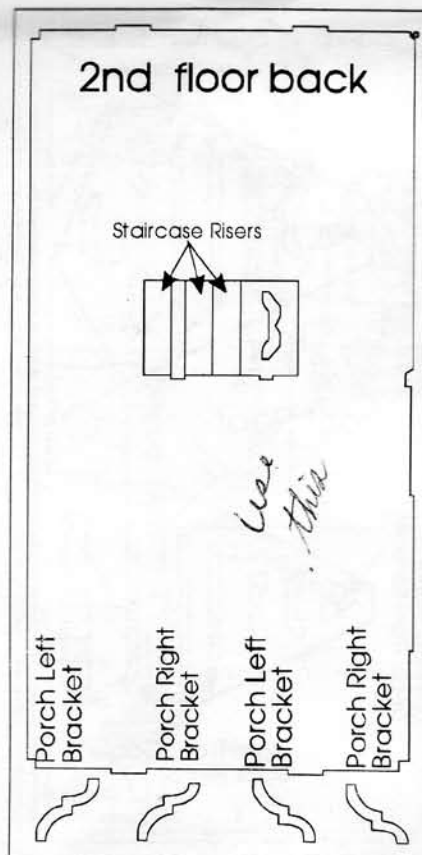

Sheet LN-5



Sheet LN-6

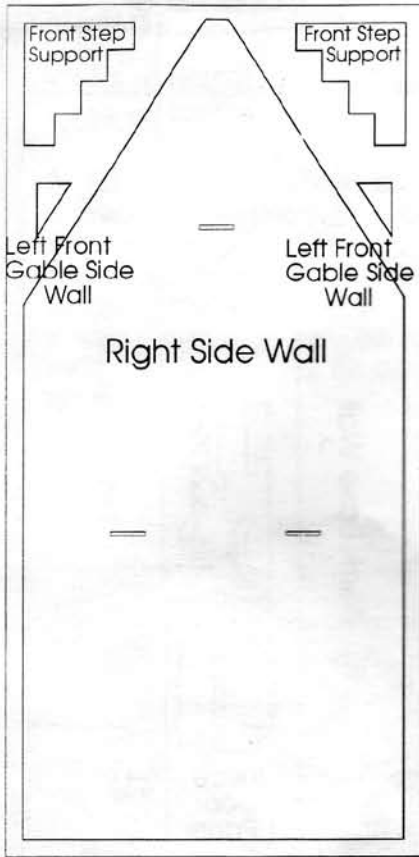

Sheet LN-7

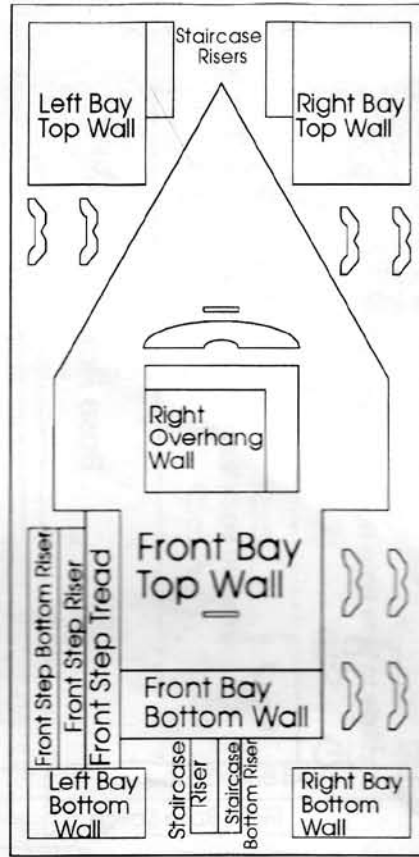

Sheet LN-8

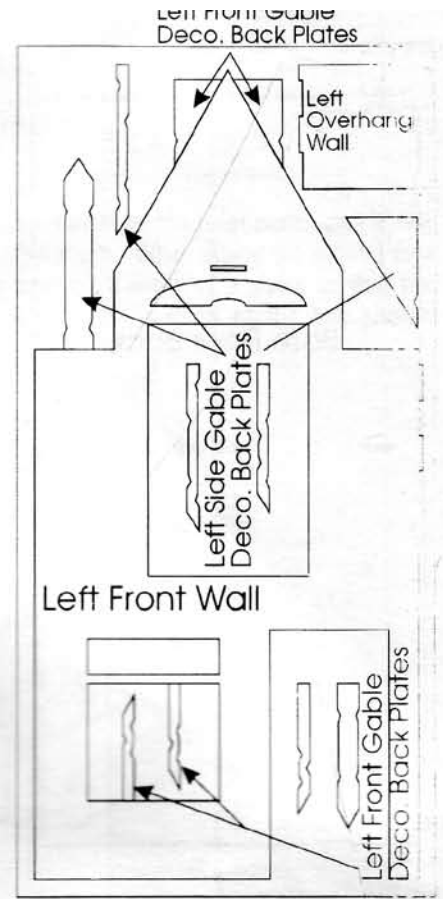

Sheet LN-9

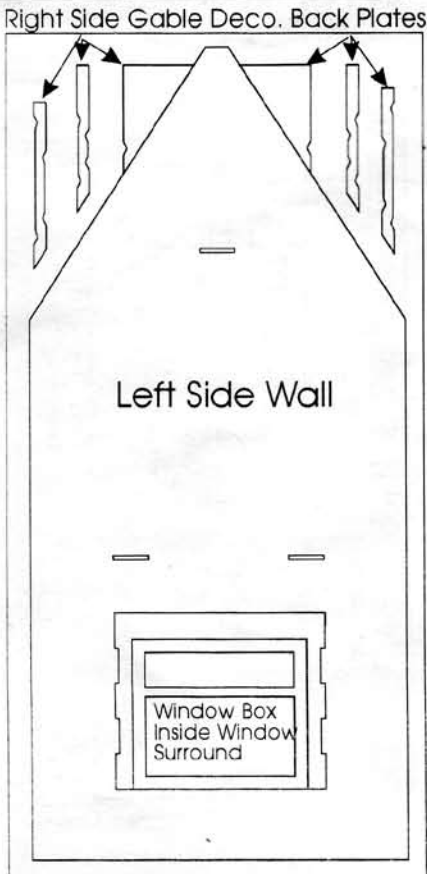

Sheet LN-10

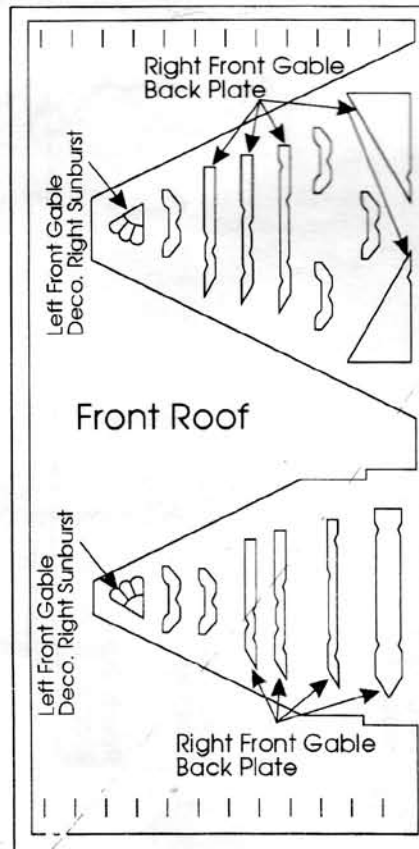

Sheet LN-11

LN 190-20

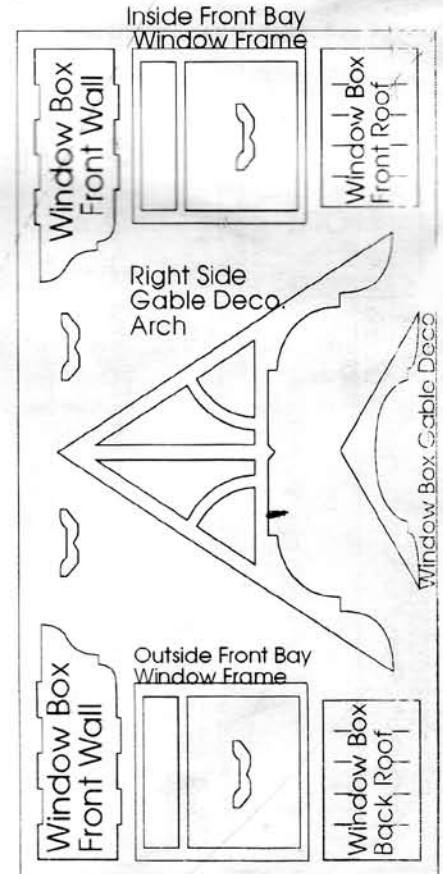

Sheet LN-12

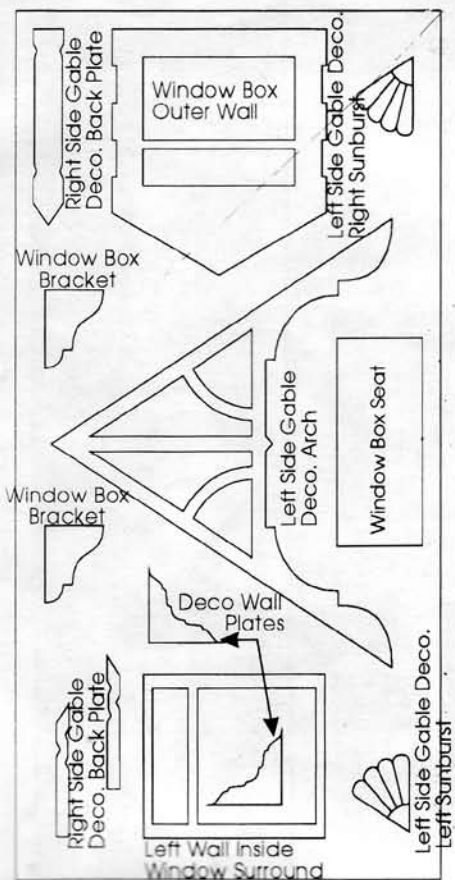

Sheet LN-13

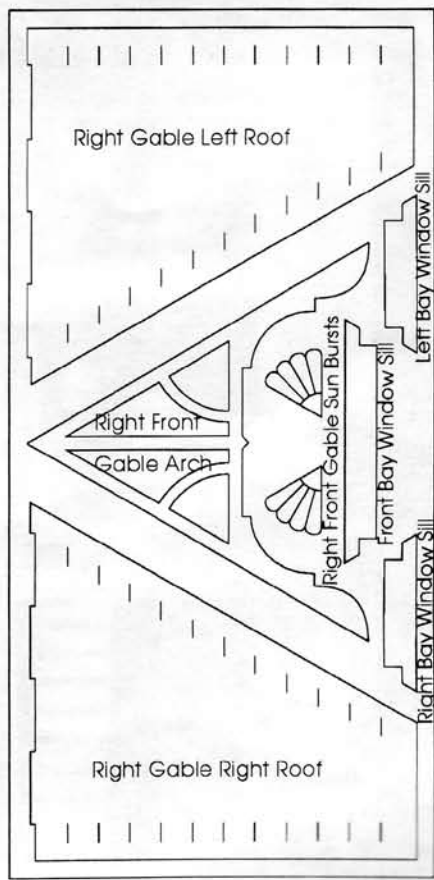

Sheet LN-14

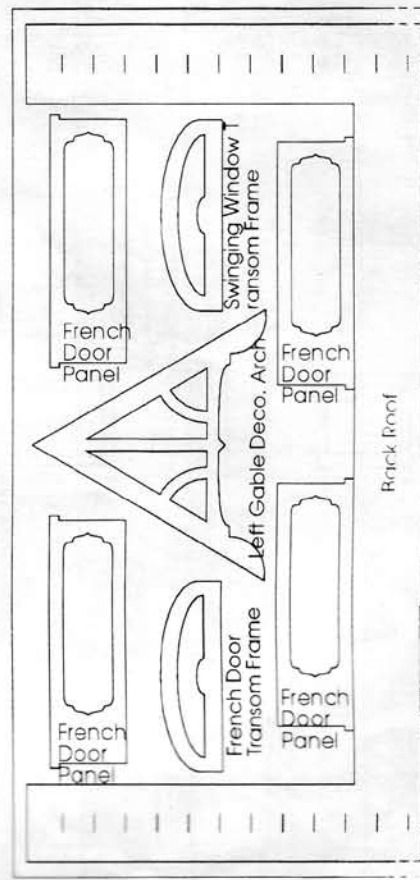

Sheet LN-15

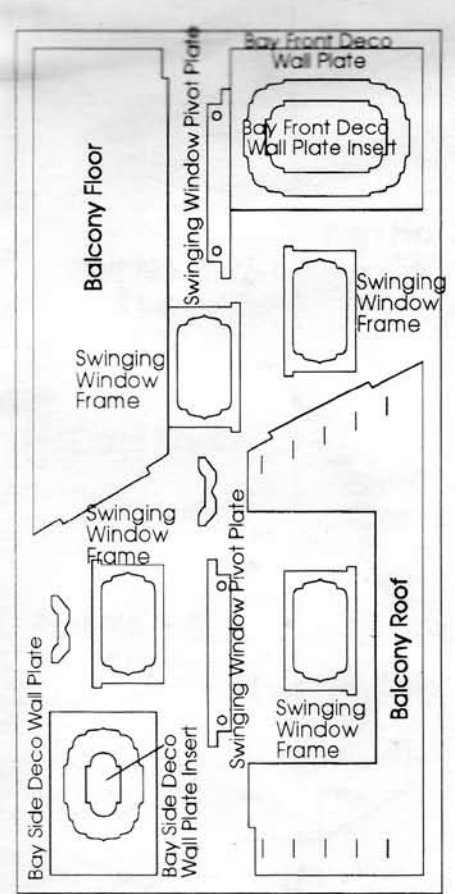

Sheet LN-16

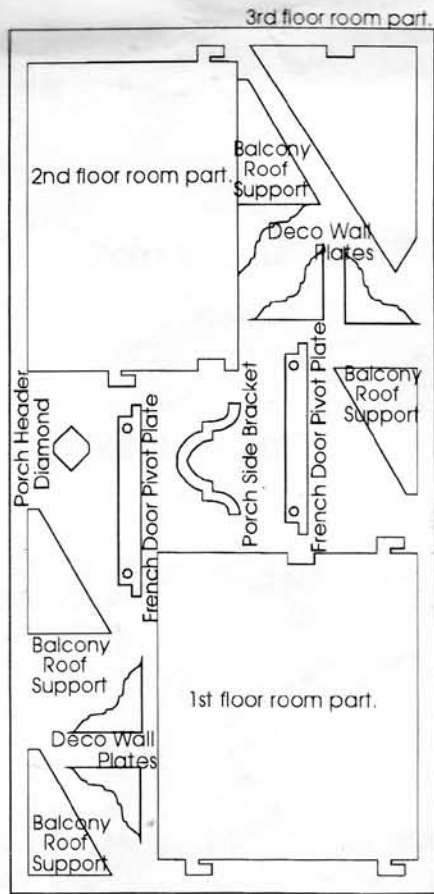

Sheet LN-17

LN 190-21

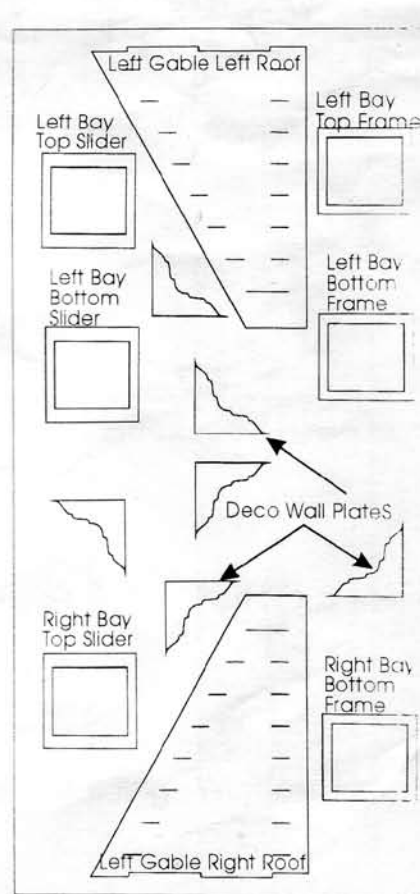

Sheet LN-18

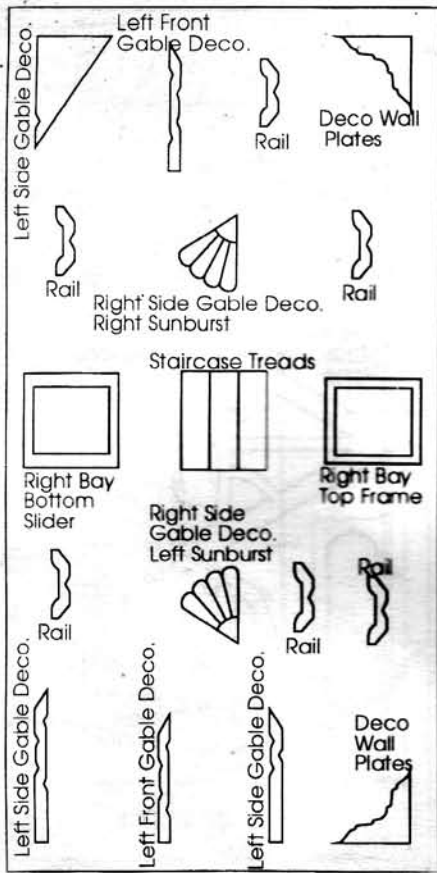

Sheet LN-19

