

# Pack DW65 Double Window

Real Good Toys  
©07/2021

## Parts:

- (4) E8155 Window Frame:  $5\frac{1}{4}$  miter  $45^\circ/45^\circ$
- (1) E8159 Middle Frame  $4\frac{7}{16}$
- (1) E8161 Trim ( $\frac{1}{16} \times \frac{3}{8}$  pine)  $4\frac{9}{16}$
- (2) E8158 Spacer  $1\frac{15}{16}$ "
- (4) J0645 Interior Window Trim ( $\frac{3}{32} \times \frac{3}{8}$ )  $5\frac{11}{32}$   $45^\circ/45^\circ$
- (2) E8157 Standard Pane (Printed Plexi)  $4\frac{5}{8} \times 2\frac{1}{8}$

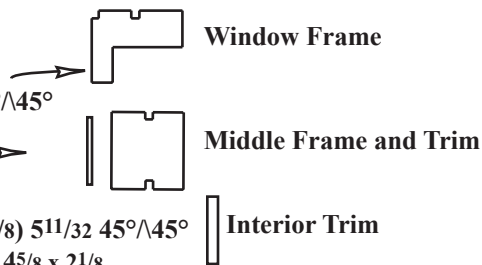

Paint the Frames and trim one-coat, then sand down to the wood. Paint the Frames on the edges shown at right, and the trim on one face and two edges. Do not let paint get on the ends.

Second-coat the paint on the grooved-face of the Frames (this will be close to the panes after assembly, and can't be second-coated then).

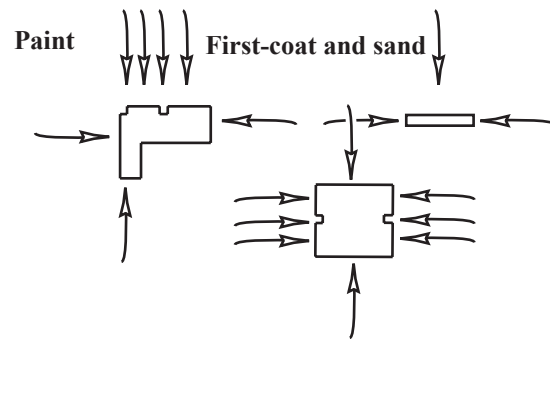

1. Spread a skimpy amount of glue on the ends of the Window and Middle Frames (5 pieces). Peel the protective film off the Panes. Assemble the Frames as shown below.



Frames, face down



Remove the protective film



the pane fits into the groove, I often do printed side out... you choose



Lay the 'Trim' to lift the Middle Frame



Engage the Middle Frame



Double Window, face-down



Tip the Trim so it doesn't interfere with the 4<sup>th</sup> Frame

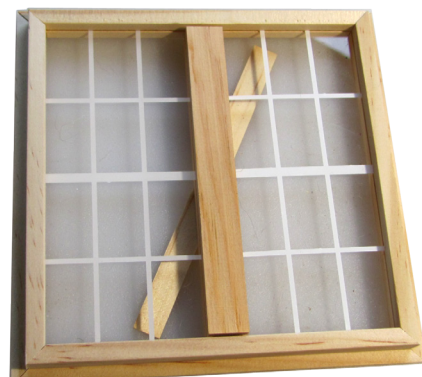

# Pack DW65 Double Window

Stretch a rubber band around the frames, a #19 or #32, or size #64 that the Postal Service uses. Work on a non-slippery surface like a piece of cardboard and **press down** on the frame set as

shown in the photos below. A snip of tape in the corners can make the process easier.

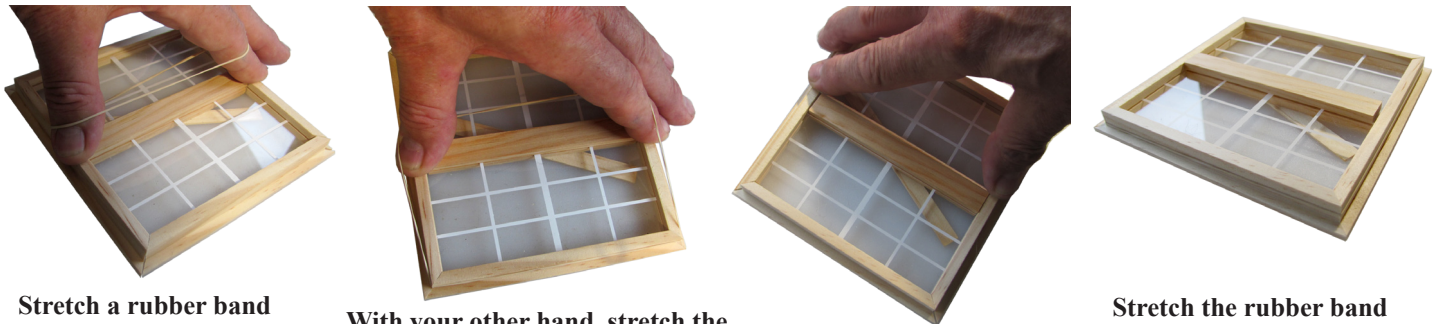

Stretch a rubber band between your fingers

With your other hand, stretch the rubber band around one end

Switch hands

Stretch the rubber band around the other end

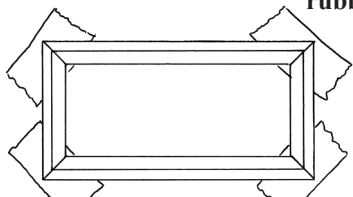

Different window, same process

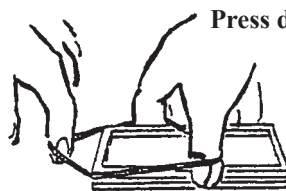

Press down... don't squeeze



Without the glue drying, turn the Window set over (remove the tape if used). Locate the Middle Frame with the Spacers.

Glue the Trim over the Middle Frame, centered and straight. Clean up excess glue, let the glue dry



Turn the set over

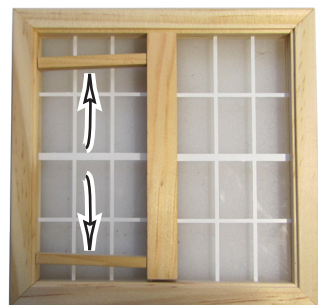

Spacers locate the Middle Frame

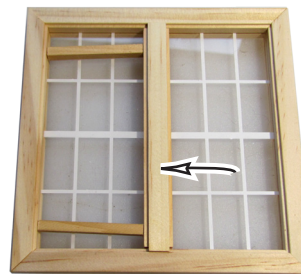

Trim



Let the glue dry

Touch-up the sanding in the corners. Paint the second coat on the face and the edges.

Do not attempt to re-paint the Frame close to the window panes at all.

Install the Window and Interior Window Trim after all painting (exterior) and interior finishing (paint, wallpaper, etc) is done. Glue and tape together the Interior Window Trim set.

Install the Window Frame set from the outside with dots of glue on the edges of the cutout. Let dry. If possible, tip the house on its front. Glue and tape or weight the Interior Trim centered and straight.

