

#DH56K The Newbury

INTRODUCTION

Congratulations on your purchase of a Batrie Dollhouse. Your dollhouse has been precision crafted in Vermont with meticulous care by our craftspeople using only the finest quality materials.

Take your time during assembly and be sure to read the instructions completely before you proceed.

This dollhouse will last for years, even generations, if proper care and attention is given during assembly.

HELPFUL HINTS

Always read through all assembly instructions before assembling the house.

Do not skip steps. Follow the instructions in the defined sequence.

- Arrange pieces in groups ready for assembly. Following the assembly instructions, assemble enough in a dry run to be sure you know ahead of time when and how each part fits. Always be sure of the parts orientation before gluing.
- Sand any rough edges or splinters before gluing.
- Use generous amounts of glue. Always wipe off excess glue immediately.
- Make all joints flush. Keep surfaces and edges square.
- Occasional changes in humidity can cause all woods to expand or contract slightly. Always "dry-fit" parts before gluing. Limited sanding or clamping may be required for proper fit.
- All Batrie dollhouse kits are inspected before shipment. However, climatic changes and handling during shipment may cause defects.

If this occurs and there is sufficient time for us to replace the part, please contact our Service Department for replacement.

Write: Real Good Toys
Customer Service Department
P.O. Box 706
Montpelier, VT 05602
(802)479-2217

Be sure to include explicit identification and measurements taken directly from the parts list for replacement parts.

Most repairs can easily be made by the kit builder. Warped parts are usually self-straightening during assembly.

- A large, clutter-free, well lighted work area is most helpful during assembly.
- Before you begin to assemble the dollhouse, it will be helpful to have the following materials handy:

Quick Grab Glue or Panel Adhesive
White glue (Elmer's)
Elastic Bands
Masking Tape
Sandpaper (medium grit)
Pencil
Ruler

Major Plywood Parts Diagram

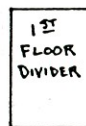
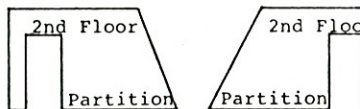
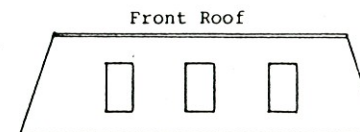
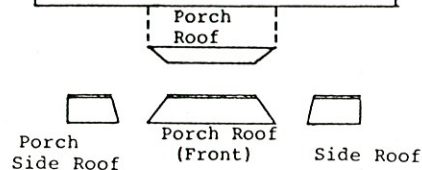
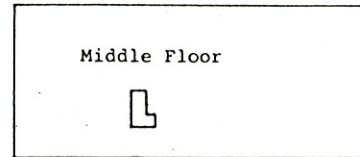
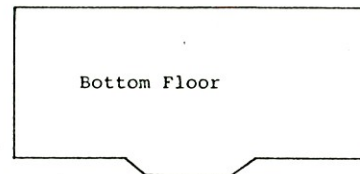

- It will be necessary to use weights when gluing to insure proper adhesion and minimize slippage. Books or other flat household objects work very well as weights in these situations.
- Read the instructions carefully, look at the illustrations and photograph on the box, and think the assembly through before you proceed.
- Identify and familiarize yourself with all the items in the kit.
- You may wish to paint all trim and clapboard siding after attaching to plywood wall panels but prior to assembly.

PARTS LIST

Instructions
Bag Shingles
Die cut stairs

Panels

- 1st Floor (Base) 31-7/8 x 15-5/16
- 2nd Floor 31-7/8 x 14
- Divider 7 x 10
- 2 Attic partition 8-3/16 x 13-1/2
- Right side roof 8-7/8 x 13-1/2
- Left side roof 8-7/8 x 13-1/2
- Front roof 31-5/8 x 8-7/8
- Roof top 25-3/8 x 10-5/8

Plywood Wall Panels

- 2 Section A 10-3/16 x 10
- 1 Section B 9-1/16 x 10
- 2 Section C 5-1/16 x 10
- 4 Section D 3-7/16 x 10

Pre-Cut Clapboard Siding

- 2 A1 10-1/4 narrow
- 4 A2/3 10-1/4
- 2 B1 2-15/16 narrow
- 2 B2 2-15/16
- 1 B3 9" with cutout
- 2 C1 5" narrow with cutout
- 4 C2 1-3/16
- 2 C3 5" with cutout
- 4 D1 3-3/8 narrow with cutout
- 8 D2 3/4"
- 4 D3 3-3/8 with cutout

Porch Roof

- Porch roof top 9-5/8 x 5/8
- Porch roof front 9 x 2-1/4
- Porch roof left side 3-5/16 x 2-1/4
- Porch roof right side 3-5/16 x 2-1/4
- Front eave 9-1/8 x 13/16
- 2 Side eave 3-3/8 x 13/16
- Front fascia 8-1/2 x 13/16
- 2 Side fascia 2-7/16 x 13/16
- 2 Flute post 8-1/2

3 W22K Dormer and Window. Each set:

- 2 Dormer side 4 x 1-9/16
- Triangle 4-1/4 x 1-1/4
- Left roof 2-13/16 x 2-13/16
- Right roof 2-13/16 x 2-13/16
- 2 Stiles 3-1/2
- 2 Sills 2"
- Plexi 2-1/8 x 3-1/8
- Stool Cap 3-1/4
- Pediment 3-1/4

2 W12K Standard Window. Each Set:

- 2 Stiles 5"
- 2 Sills 2"
- Plexi 2-1/8 x 4-5/8
- Stool cap 3-1/4
- Pediment 3-1/4

4 W40K Narrow Window. Each Set:

- 2 Stiles 5"
- 2 Sills 1-3/16
- Plexi 1-5/16 x 4-5/8
- Stool cap 2-7/16
- Pediment 2-7/16

D11K Door

- Door panel 6-3/8 x 2-7/16
- 2 Stiles 7-1/4
- Header 2-1/2 drilled
- Threshold 2-1/2 drilled
- Pediment 4-3/8 mitered
- Nail 1/2"
- Nail 1-1/4"

Trim and Rail

- 2 Left miter rail 3-1/8
- 2 Right miter rail 3-1/8
- 8 Left miter rail 2-5/16
- 8 Right miter rail 2-5/16
- 4 Rail 1-1/4
- 2 Flute post 1-5/8
- 4 Flute post 2-5/8
- 6 3/8" balls
- 6 Post caps
- 8 Brackets
- 16 1" Dowel
- 32 1-3/4" Dowel

Connectors

- 2 End cap
- 8 135° connector

WINDOW ASSEMBLY DIAGRAM

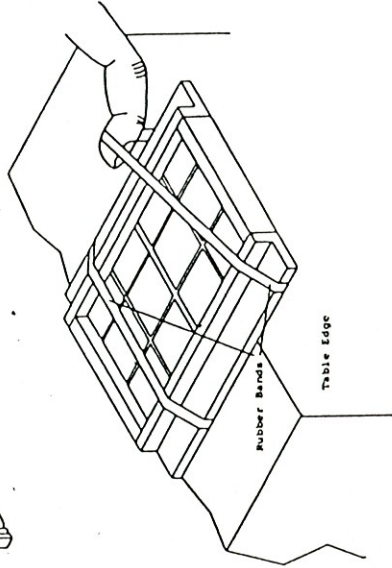
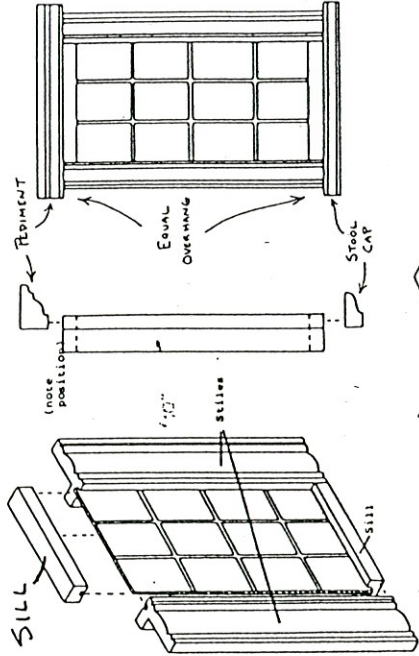

GLUING PATTERN

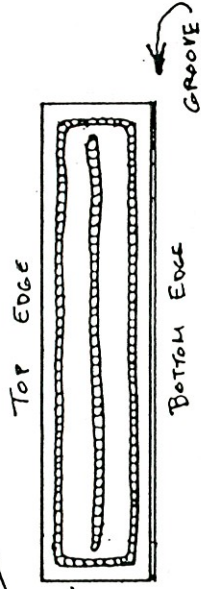

- Pre-Cut Clapboard Siding
- 2 A1 10-1/4 narrow
 - 4 A2/3 10-1/4
 - 2 B1 2-15/16 narrow
 - 2 B2 2-15/16
 - 1 B3 9" with cutout
 - 2 C1 5" narrow with cutout
 - 4 C2 1-3/16
 - 2 C3 5" with cutout
 - 4 D1 3-3/8 narrow with cutout
 - 8 D2 3/4"
 - 4 D3 3-3/8 with cutout

GROOVED EDGE FITS OVER LOWER CLAPBOARD

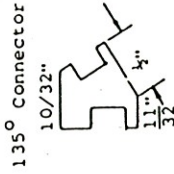
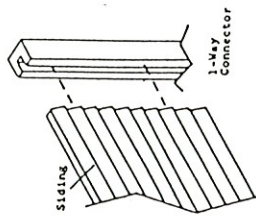

Proper Orientation of connectors to wall sections

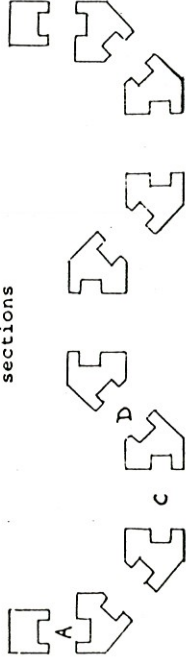

3) ASSEMBLE HOUSE BODY

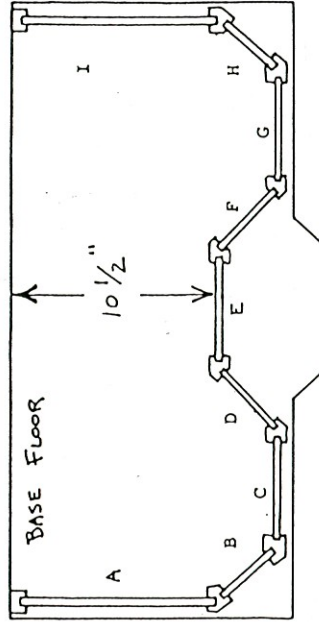

1) WINDOW ASSEMBLY

The W12K, W22K and W40K window kits are assembled according to the following procedure:

- a) Identify and arrange the parts in the kit using the assembly diagram as an aid. Be sure of parts orientation before gluing.
- b) Put a dab of glue on both sides of the sills.
Refer to the Assembly Diagram.
- c) The plastic window is inserted into the grooves on the vertical stiles, header and sill and pushed into position as shown in the Assembly Diagram.
- d) Slide the window over the edge of the table and wrap one end with an elastic band, as shown in the Assembly Diagram. Carefully turn the window around and wrap an elastic band around the other end.
- e) Check to see that the window is square at the corners. The header and sill should be flush at the top and bottom.

NOTE: These parts are not glued flush to the rear of the window frame and should be installed as shown in the Assembly Diagram.

- f) Allow the window unit to dry thoroughly before using.
- g) If too tight during assembly sand or file the window opening to fit.

2) APPLY PRE-CUT CLAPBOARD TO WALL PANELS

- a) This Batic kit includes completely pre-cut Northeastern clapboard siding, designed to precisely fit your individual dollhouse.

The clapboard siding should be applied to the wall panels prior to assembly. Note the diagram shown here. It shows the layout for the entire house. Lay out the clapboard as shown.

- b) Be sure of clapboard location and fit before gluing. Only "sandpaper accommodations" are necessary for a good fit.
- c) Use the proper glue such as "Quick Grab" and follow the manufacturer's instructions. Do not use a water-based glue.

It is very important that this clapboard siding is thoroughly glued. We recommend the gluing pattern shown using enough glue to get full coverage when pressed out on the house. Cleanup is possible with rubber cement solvent.

PLEASE read all instructions and dry fit all parts before opening your glue tube.

- d) Glue the clapboard in place beginning at the bottom edge of each panel. Make sure the clapboard is flush along the entire bottom edge, then finish gluing on clapboard working from bottom to top.
- e) The rounded corners of the routed openings need to be cut square. This is easily done as shown using a sharp knife.

CLAPBOARD SIDING LAYOUT DIAGRAM

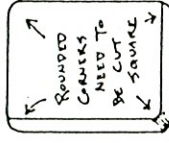
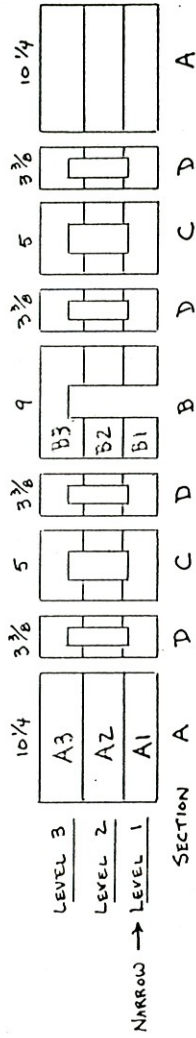

The rounded corners of the routed openings need to be cut square. This is easily done as shown using a sharp knife.

- a) Following the diagram showing the proper orientation of connectors and wall sections, assemble these parts without glue (dry-fit) in position on the base floor. Use masking tape. Assembly is flush at rear and evenly spaced side to side. Pay particular attention to the position of all 2-way connectors. See diagram.

SPECIAL NOTE: The proper distance from the rear edge of the floor to the inside of clapboard section E is 10-1/2".

- b) When satisfied with this assembly trace outline. Then starting at one end reassemble with glue.
- c) Glue 2nd floor panel in place evenly spaced. Use weight and tape. Make sure rear edge of end wall sections are flush at rear, and that everything is set square.

4) ROOF ASSEMBLY

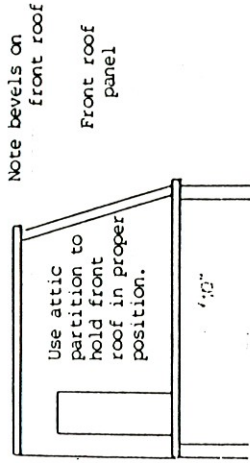

- a) Shingling preparation:
1. This is the easiest time to draw guidelines for locating shingles on the roof panels, before roof assembly. The first guideline on all panels to be shingled should be drawn 1/4" (shingle length) from the bottom edge.
 2. Pay particular attention that the guidelines are drawn on the outside of all roof panels.
 3. Space 1" on the left and right side roof panels and the front roof panel.

Note: That the front roof overhangs the side roof.

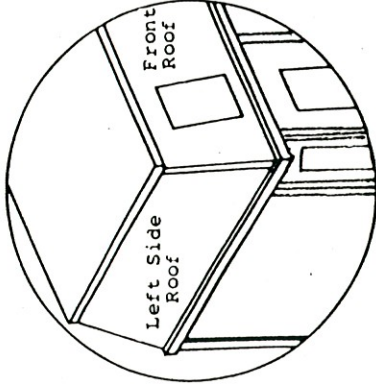

- b) Assemble the roof panels.
1. Starting with the front roof, apply one or two strips of masking tape near the left and right end of the roof, allowing about 3 to 4 inches of the tape to overhang the ends, flap like.

Note: The front roof is beveled at the top and bottom. See diagram for proper positioning.

2. Next, locate the left and right side roofs and apply a bead of glue to the front edges of each and also to the bottom edge of the front roof and the side roofs.
3. Now, position these three roof sections as shown in diagram and tape together into position using the flaps from the front roof.

Note: You may wish to wait and install the top roof panel after shingling.

4. Apply a bead of glue to the top of the roof sections just installed and place the top roof into position as shown. The left and right side roofs should be flush to back of top floor, and the top roof should also be flush to the back of the side roofs with the overhang equalized. Apply additional holding tape as needed. Be sure and wipe off all excess glue before it sets up.
5. The top roof should be lightly weighted down to assure good adhesion. (Temporarily install angled partitions to support weight while glue is drying.)

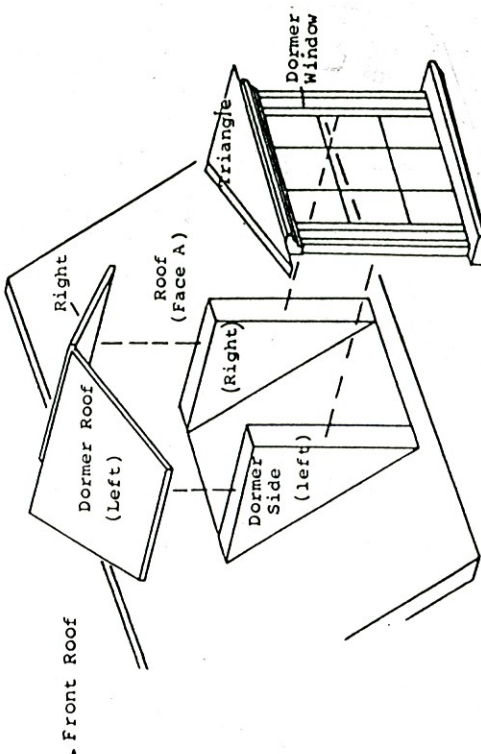
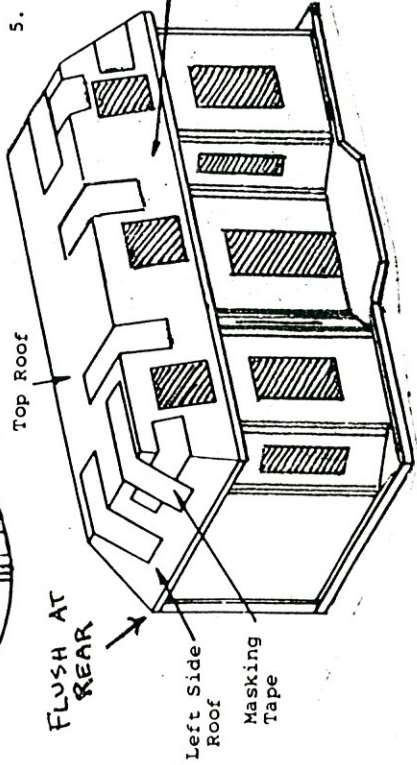

5) ASSEMBLE DORMERS

- a) Glue dormer triangle on top of W22K window assembly (9-pane window). Back of triangle is flush with back edge of pediment, centered side to side.
- b) Glue dormer sides to window assembly flush at sides and flush at bottom edge.
- c) Attach this assembly to roof. Trim the bottom corners of dormer openings for proper fit. Glue, let dry.
- d) Attach the left and right dormer roofs simultaneously.

6) PRE-ASSEMBLED WINDOWS

Install all the pre-assembled windows in the appropriate openings. The tongue of the exposed clapboard siding must be trimmed.

DOOR ASSEMBLY
DIAGRAM

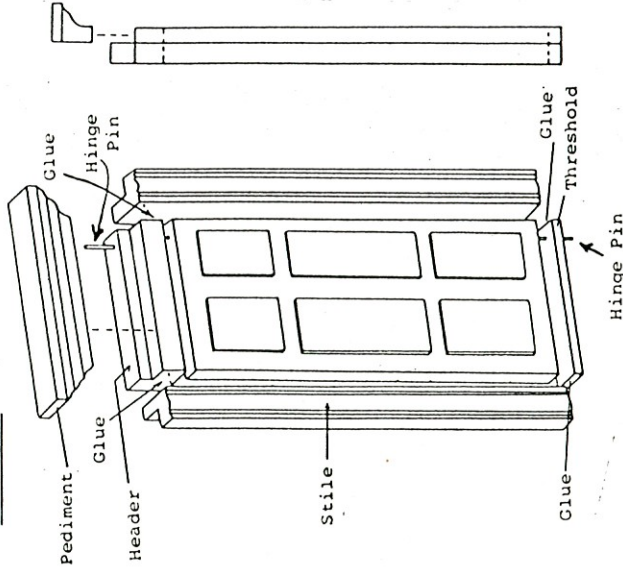

7) FRONT DOOR ASSEMBLY

Assembly instructions for the standard Batrrie door:

- a) Refer to the Assembly Diagram and identify and arrange the door parts.
- b) Apply glue to each end of both the header and threshold. Check parts orientation before gluing.
NOTE: The pre-drilled hole in the header and threshold should be at the right side.
- c) Assemble the parts as shown in the Diagram and wrap securely with elastic bands around each end of the frame. Check to see that the door frame is secure and the header and threshold flush with the sides of the frame.
- d) After the glue has dried, install the door. The door has a beveled edge, the beveled edge is the "hinge" on the right side and permits easy opening and closing.
- e) Using the nails provided in the hardware kit push the shorter nail through the hole in the threshold and into the door.
The longer nail goes through the header.

NOTE: Be sure to center the nails to avoid splitting the door.

- f) Finally, glue the decorative door pediment, if required, into place as shown in the Assembly Diagram.

- g) If too tight during assembly, sand or file the corners to fit.

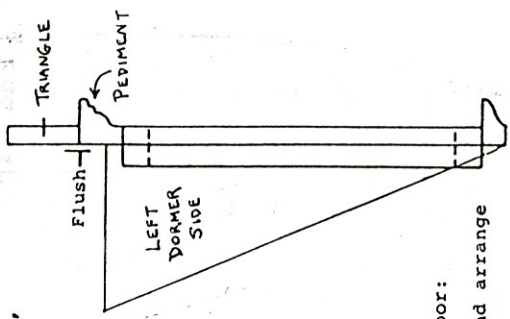

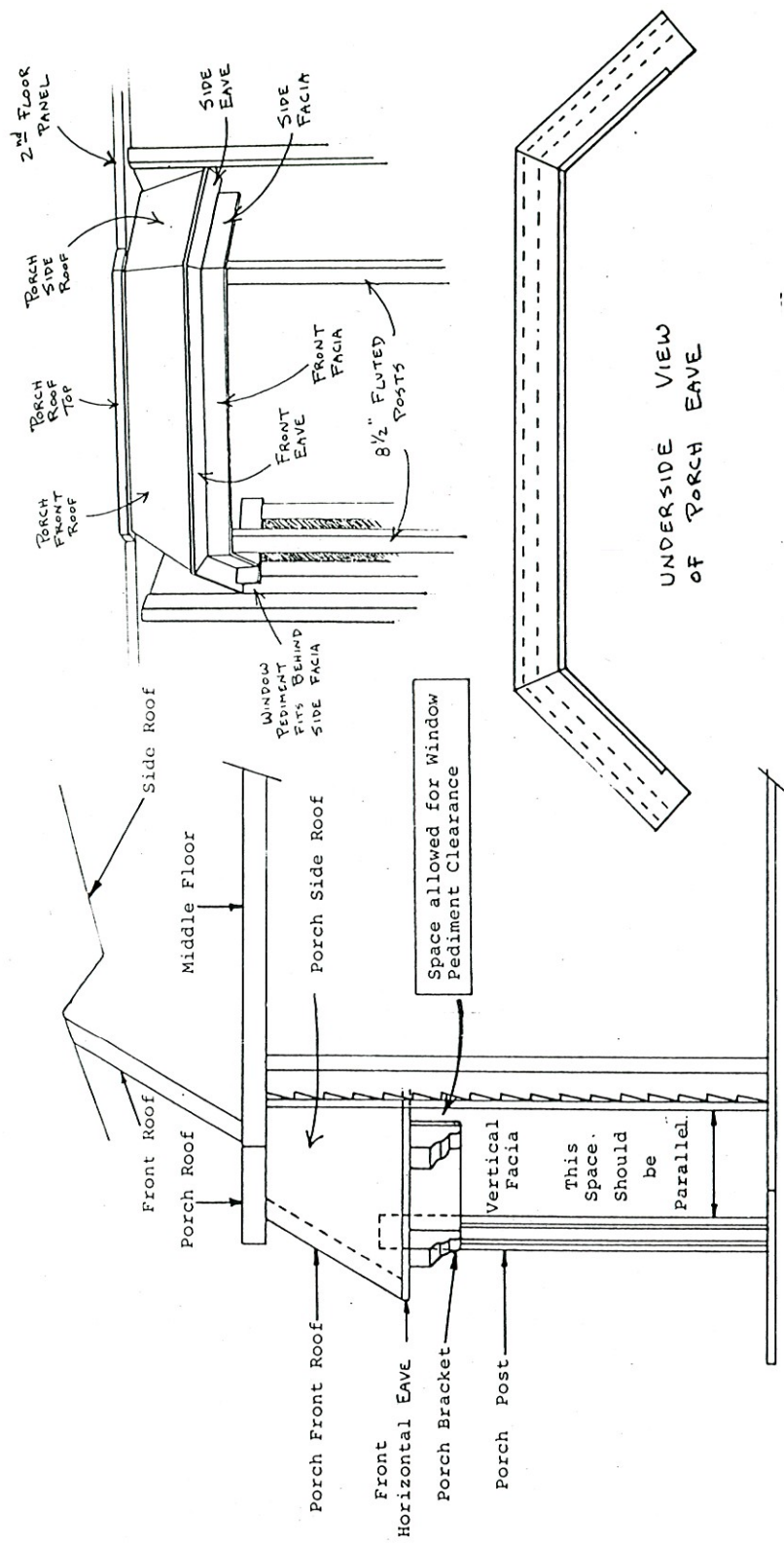

8) FRONT PORCH ASSEMBLY

a) Glue together (3) porch eave pieces as shown.

b) Glue (3) porch roof panels together, using masking tape and glue. Let dry.

c) Glue roof assembly to horizontal porch eave, flush at ends with an even overhang.

d) Glue (3) facia pieces together. Let dry.

e) Then glue the facia assembly to underside of the eave assembly, flush at the rear edge.

f) Turn house upside down and glue entire roof assembly in place. Glue to floor panel and clapboard.

The tips of the horizontal eave may have to be trimmed slightly for proper fit.

g) Glue 8-1/2" porch post in place behind the front facia as shown.

h) Glue porch roof top in place centered side to side.

SIDE VIEW

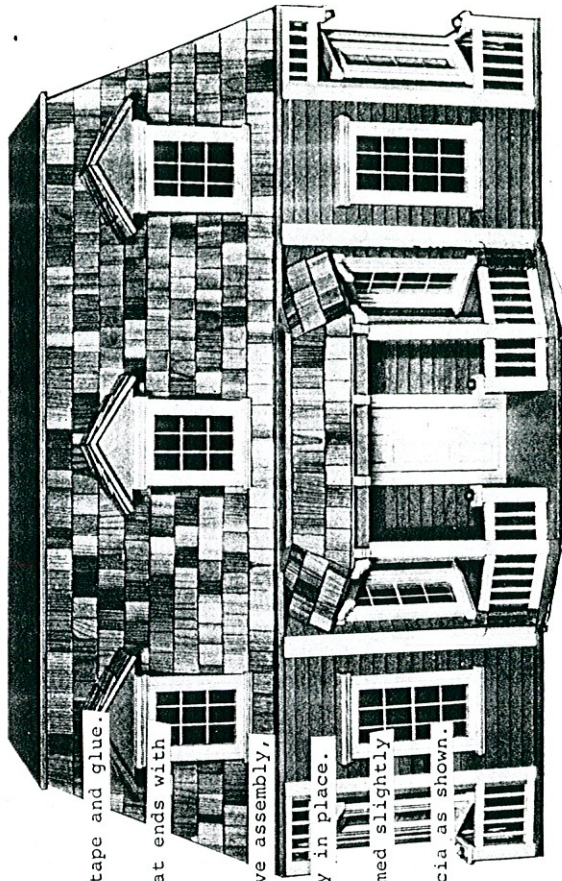

EXTERIOR TRIM

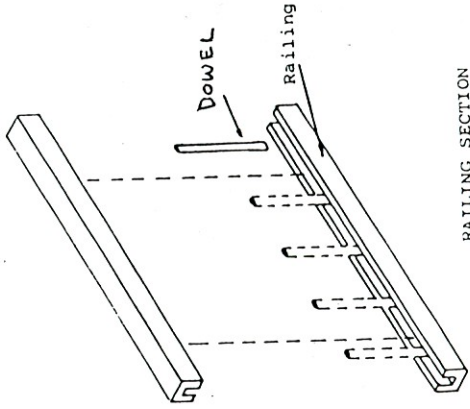
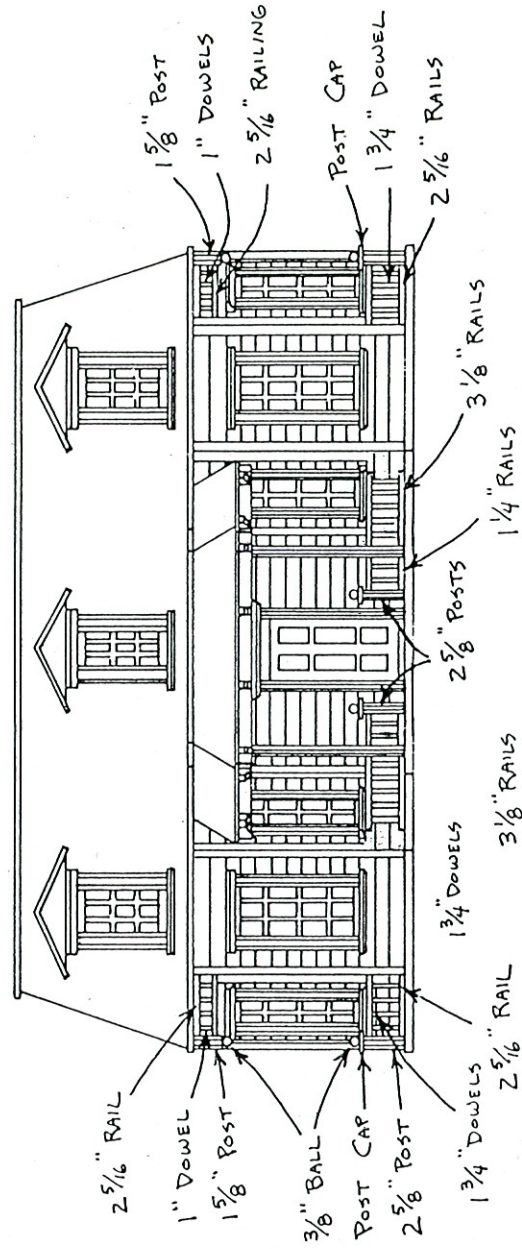

RAILING SECTION

9) POST AND RAILING ASSEMBLY

a) All the rail assemblies should now be assembled. Use the illustrations to identify the proper orientation of rail assemblies.

b) For each pair of railings mark location of spindles every 5/8".

c) Apply a dab of glue to the bottom of each spindle and install as shown.

Be sure all spindles are perfectly upright and perpendicular. Install the top railing only after the spindles have dried.
d) After all the railing sets have been completed install them into position on the dollhouse.

Use Diagram for correct orientation. The posts are installed by merely applying a dab of glue to the bottom of each post.

10) ASSEMBLE STAIRS

- a) Punch out parts from die sheet.
- b) There are three stair sides. Match the two best sides.
- c) Glue on 2nd from top and bottom stair backs. Stair backs must be flush with tread surface. Trim or elevate if necessary.
- d) Glue on the rest of the stair backs. The top stair back should protrude.
- e) Glue on the treads, except the top tread.
- f) Square out the front edges of the stair hole.
- g) Glue the top tread into the hole, flush with the floor surface.
- h) Glue stair unit into position.

Top View
Stairwell

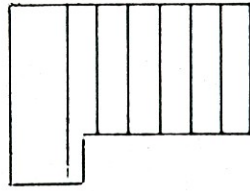

Tread 11/16 wide

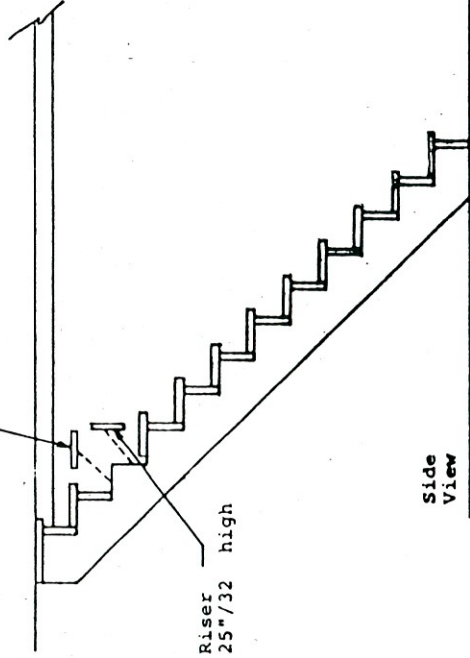

Side
View

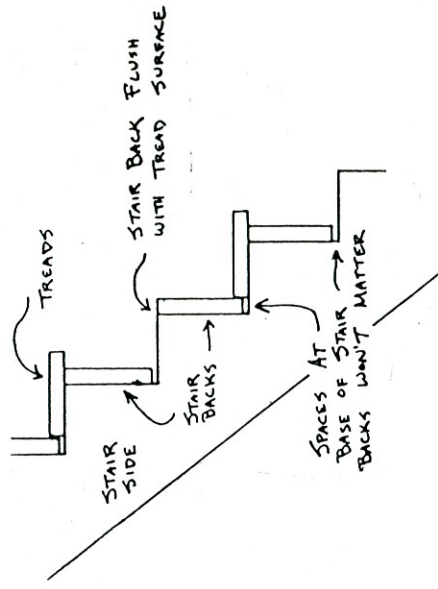

SUGGESTED ROOM LAYOUT

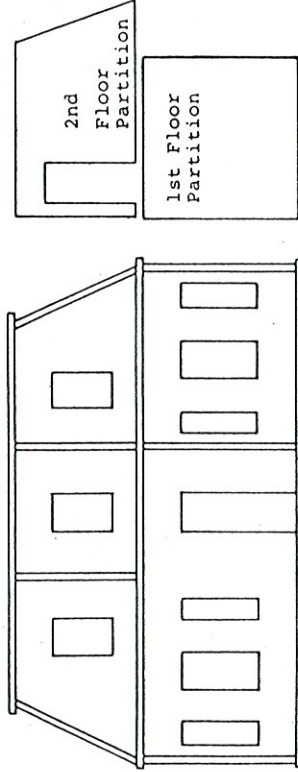

BACK VIEW

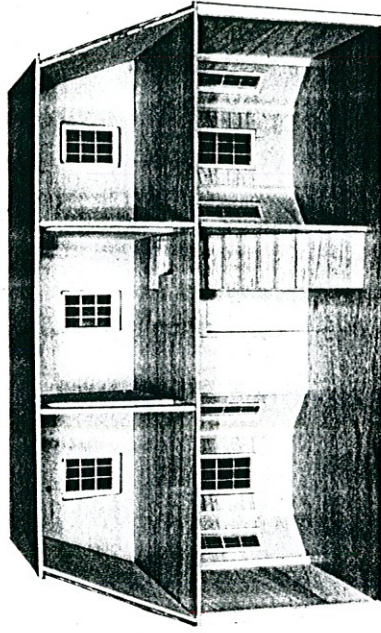

- 11) We recommend temporary placement of dividers, using rubber cement or dots of glue so that they can be easily removed for interior decoration. See diagram.

12) SHINGLE THE ROOF

- a) Wooden shingles provided are enough to cover all roof surfaces except the top roof panel.
- b) Use a 1" reveal on all roof panels.
- c) Where two roof panels meet, shingle the side roof first. Let shingles overlap the corner, then trim from the bottom to the top. Then shingle the front roof.

