

FIRST & SECOND FLOORS

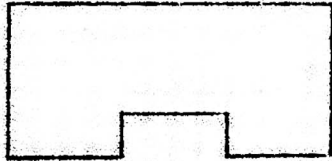

3RD FLOOR

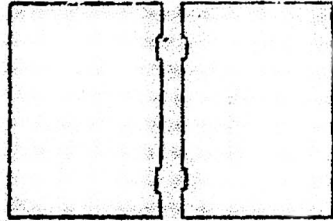

LEFT SIDE

RIGHT SIDE

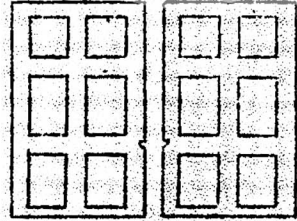

LEFT FRONT

RIGHT FRONT

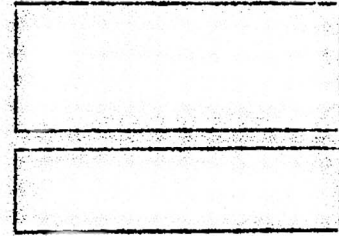

UPPER BACK

LOWER BACK



FRONT ROOF

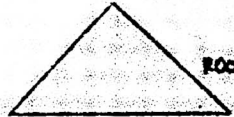

ROOF SIDE (2)



REAR ROOF

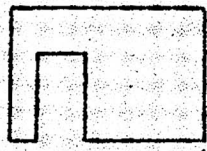

ROOM DIVIDERS (4)

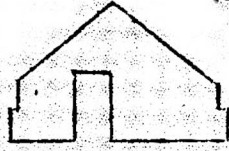

ATTIC PARTITIONS (2)

PORCH CEILING



MIDDLE FRONT



PORCH FLOOR

STAIR UNIT BACK

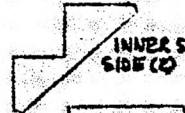

INNER STAIR SIDE (2)

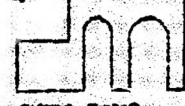

OUTER STAIR SIDE (2)

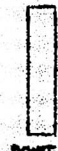

BOWL TOP

LEFT PORCH ROOF



RIGHT PORCH ROOF



PORCH TRIANGLE

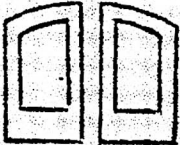

DOORS (2)



STAIR SIDE SPACERS (4)



CHIMNEY FRONT (2)



CHIMNEY BACK (2)



CHIMNEY SIDE (4)



CHIMNEY TOP (2)



CHIMNEY TRIM (4 OF EACH)



FIRST STEP (PINE)

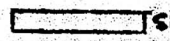

SECOND STEP (PINE)

SECTION I

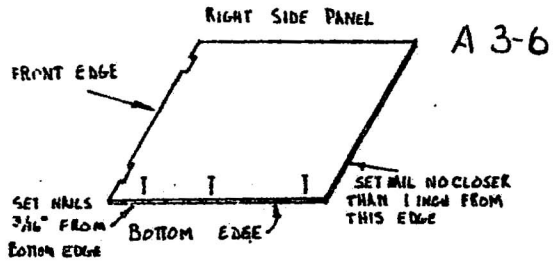

NOTE: Do NOT NAIL THROUGH PANEL.

A.5-9

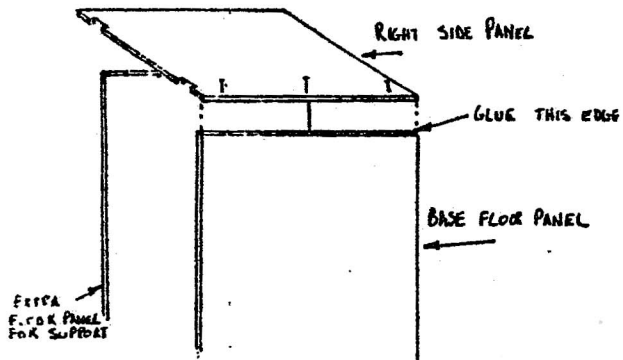

SECTION I

B1

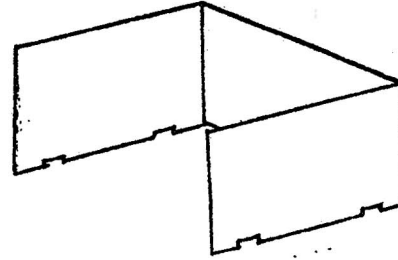

B3-4

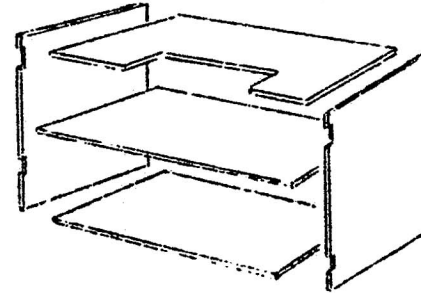
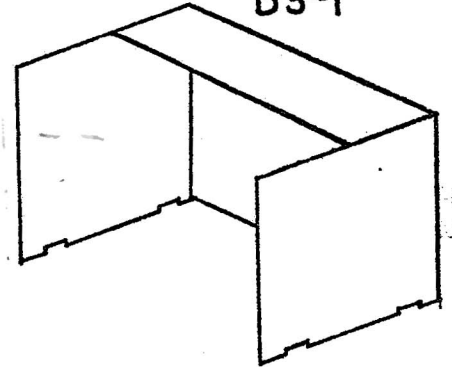

B&C
Floor & Side Wall
Arrangement

B&C
Back Panels

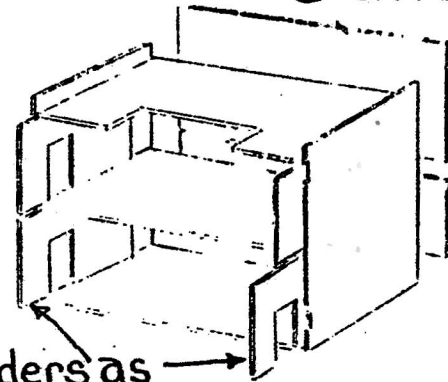

Use Dividers as
Spacers for floors

SECTION I.

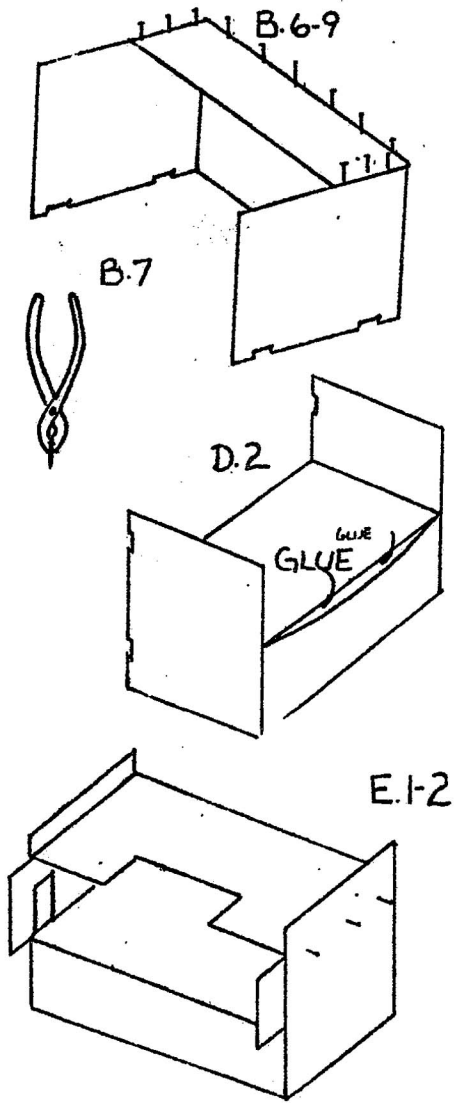
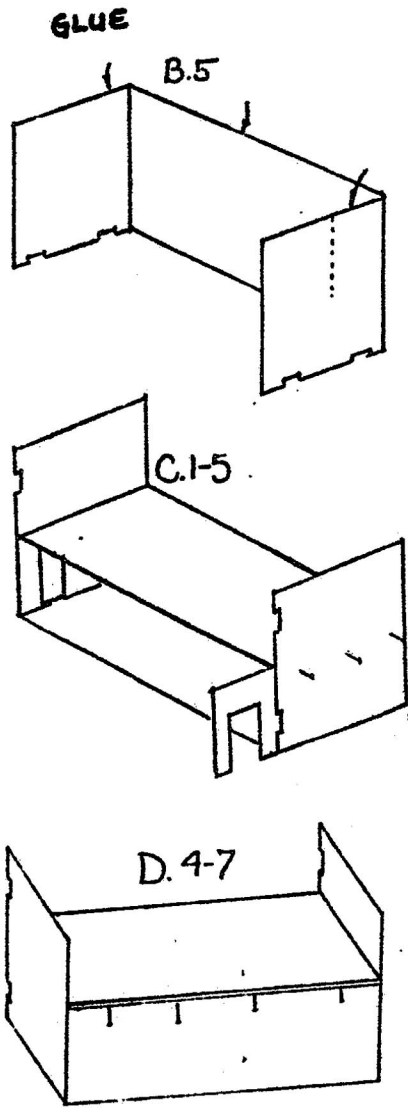

SECTION I

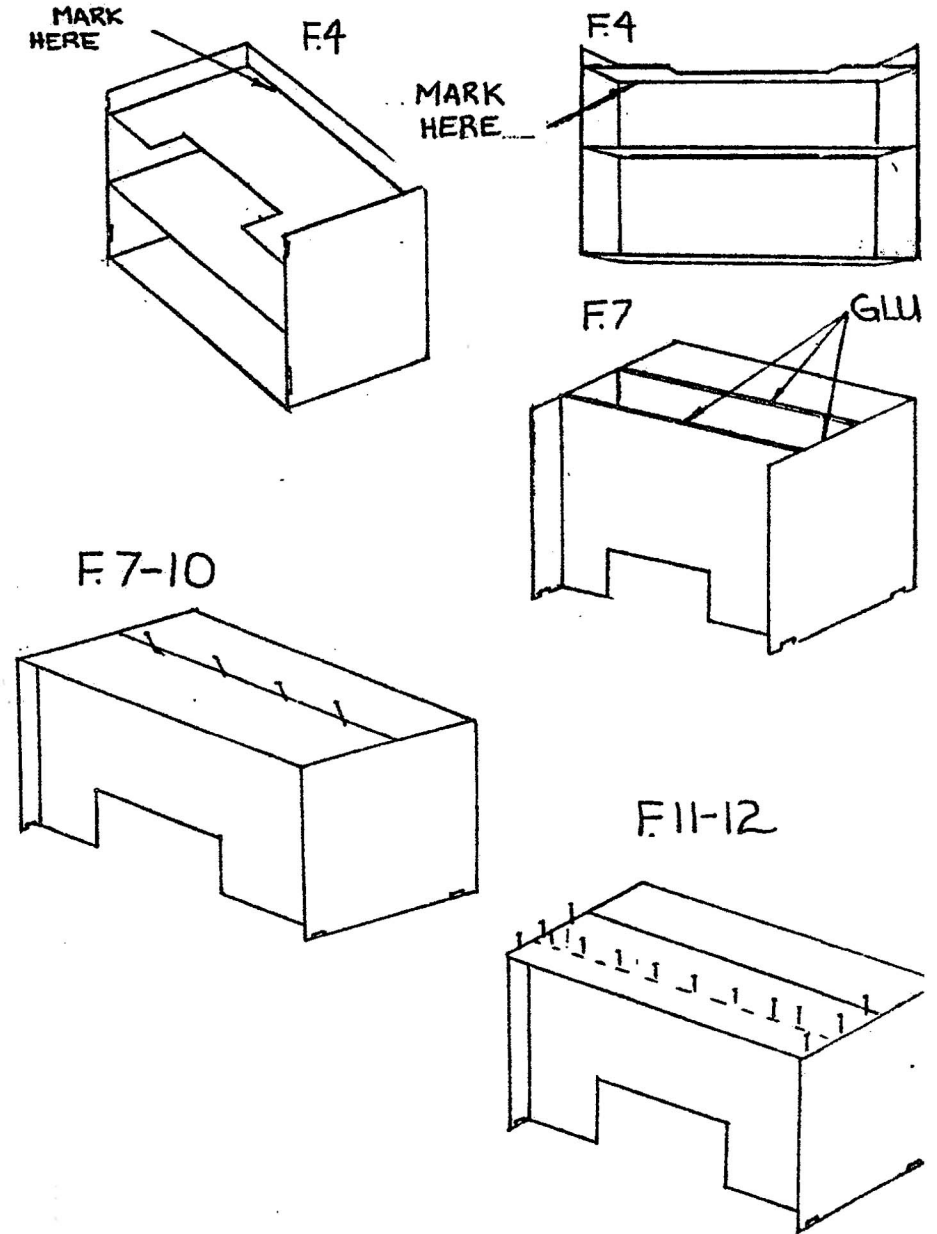

Section I

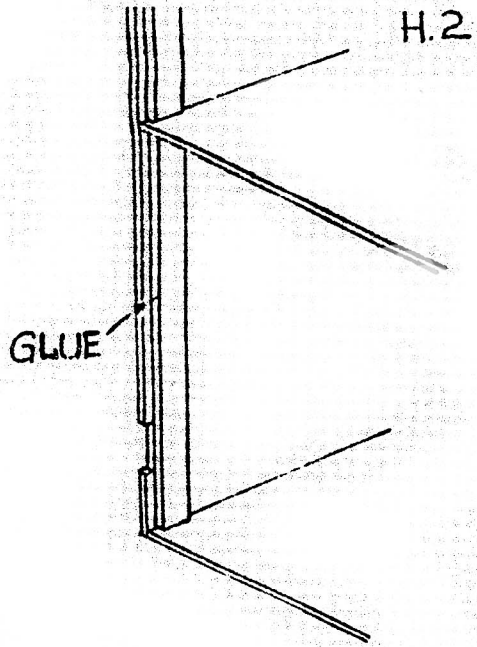

H.2

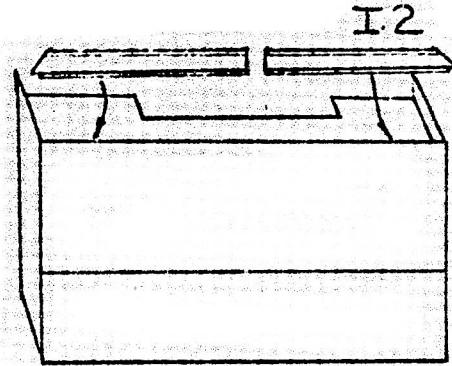

I.2

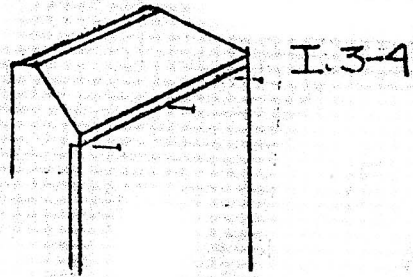

I.3-4

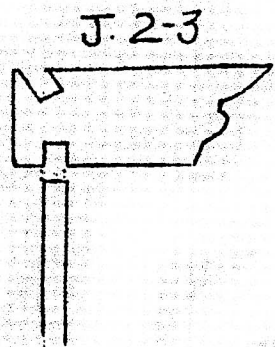

J.2-3

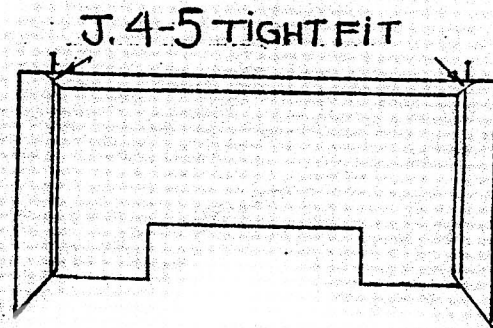

J.4-5 TIGHT FIT

Section II

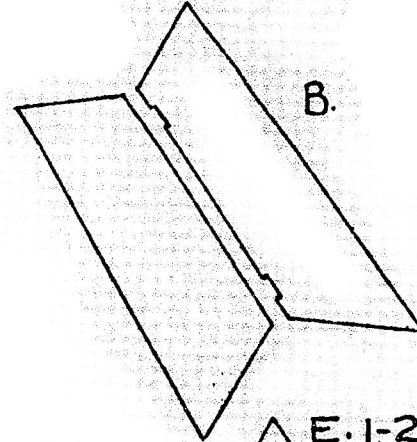

B.

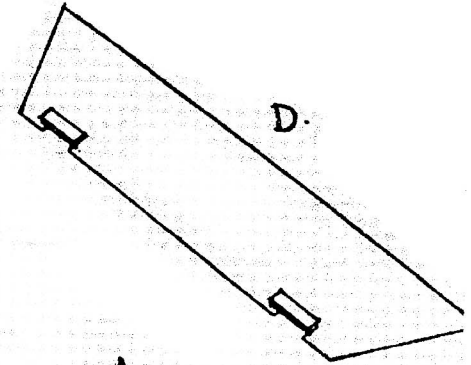

D.

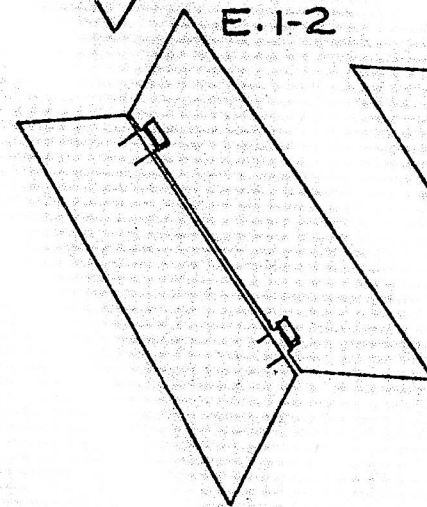

E.1-2

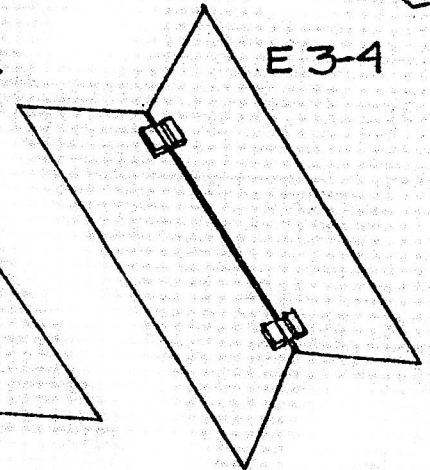

E.3-4

SECTION III.

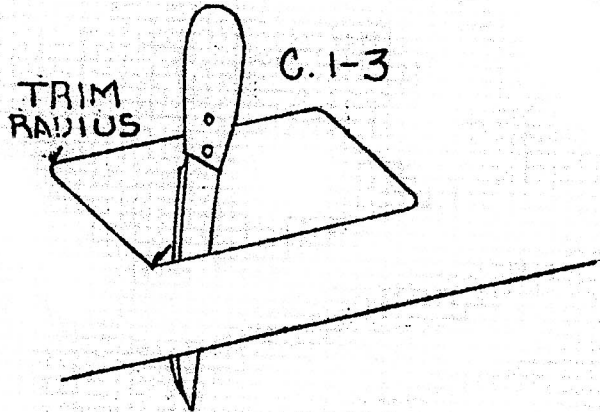
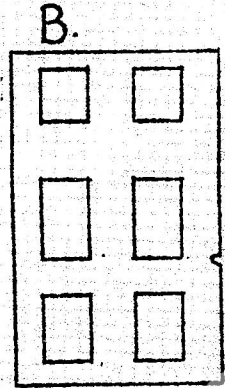

C.4b.

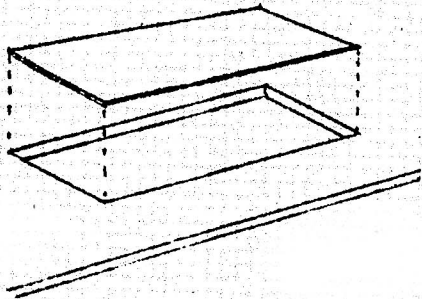

D.2-4c.

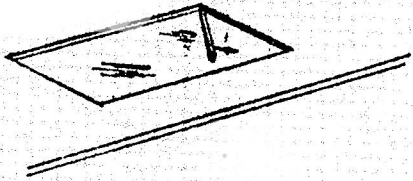

D.5-6

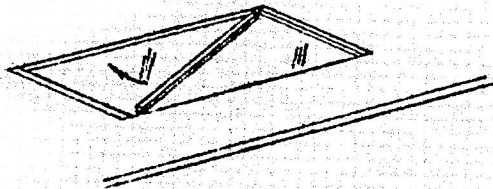

D.4d-f



Section III

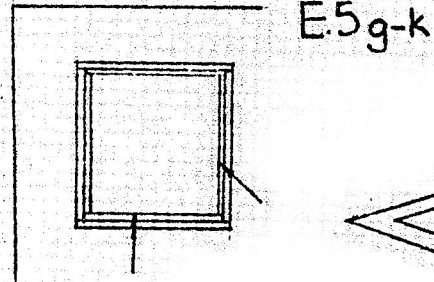

E.5d-e

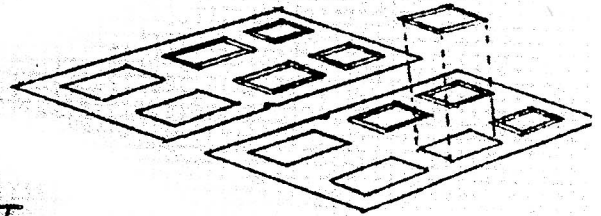

Section IV.

C.1-2



C.3a-c

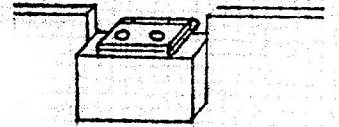

C.4

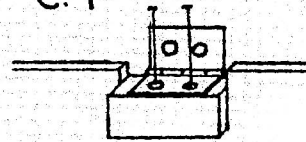

C.5

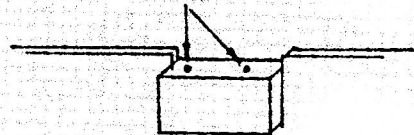

C.6-8

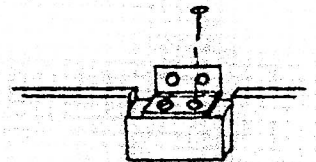

Section IV.

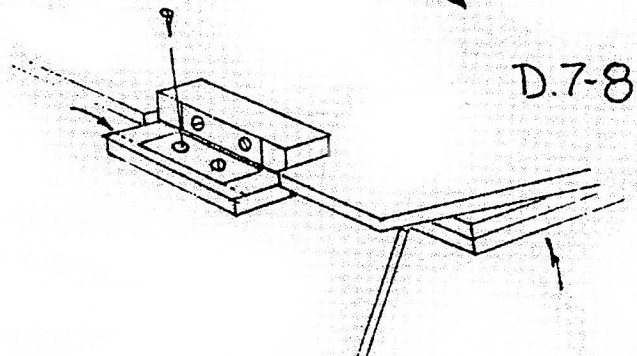
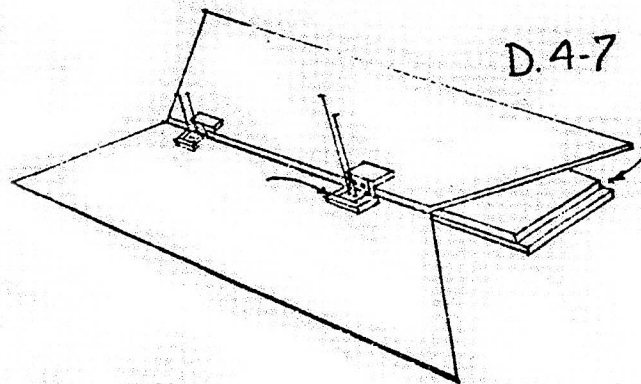
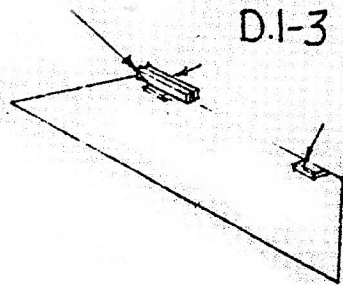

Section V

B.1-6

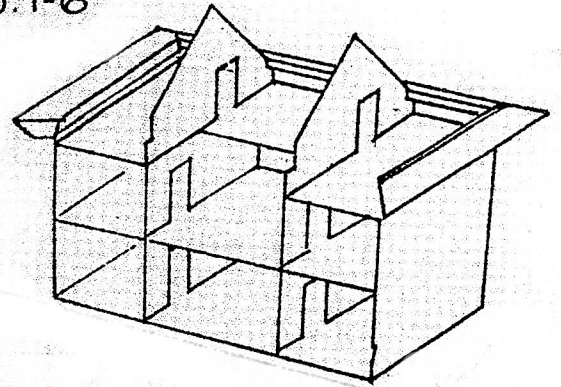

C.2-4

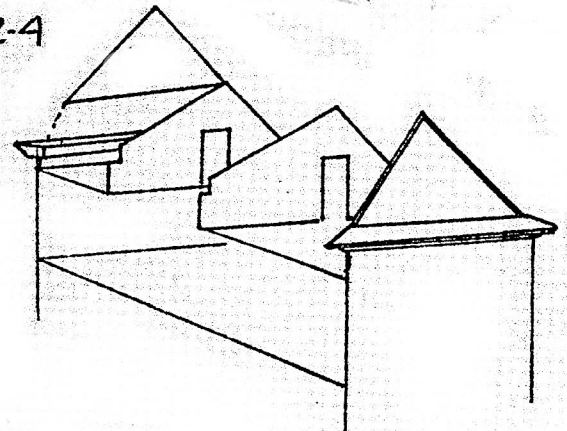

C.5

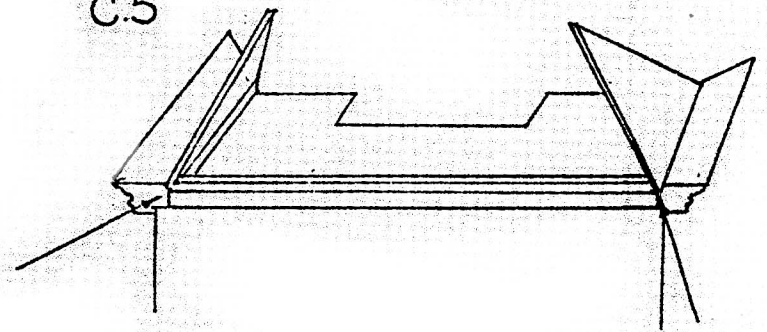

Section V

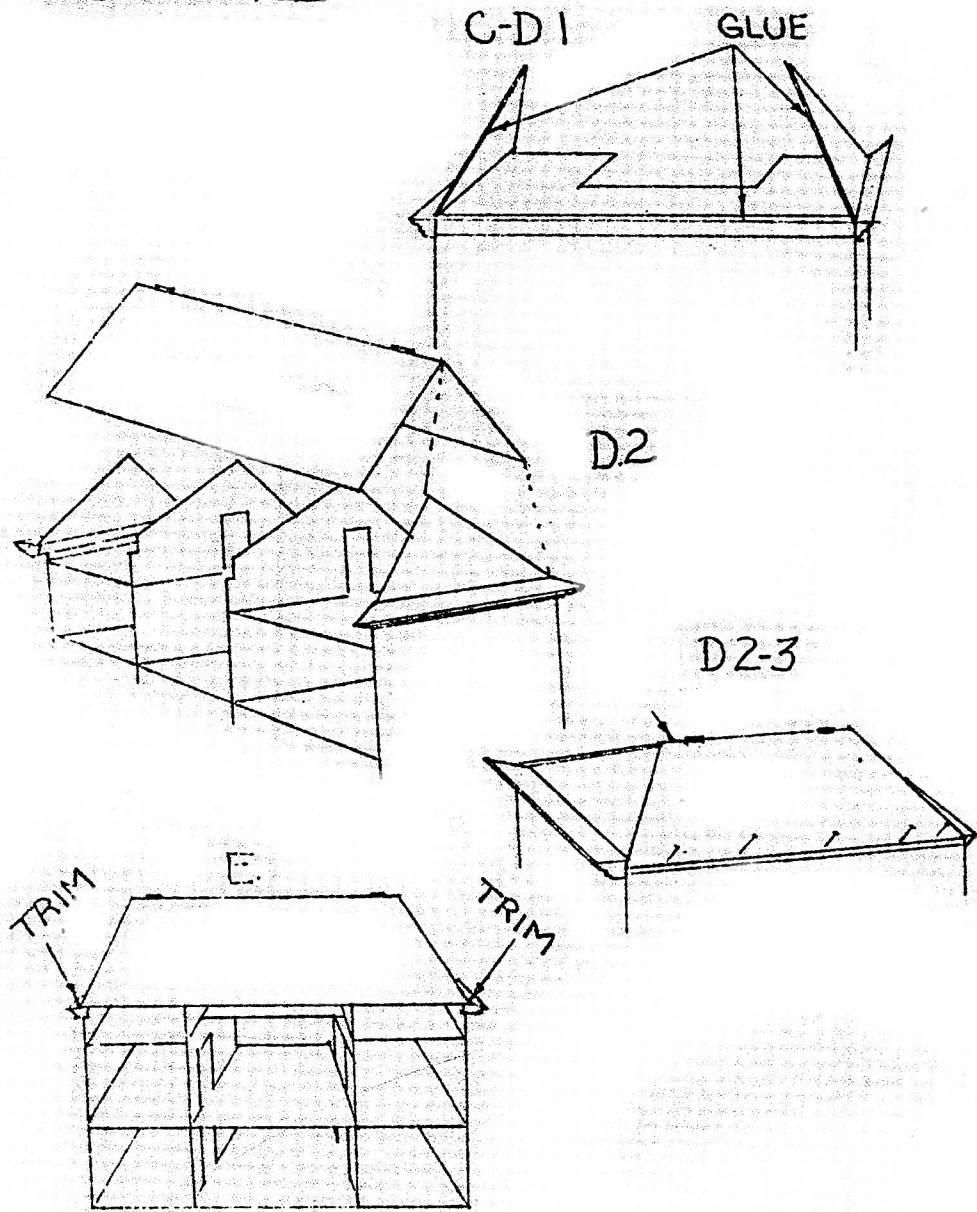

Section VI

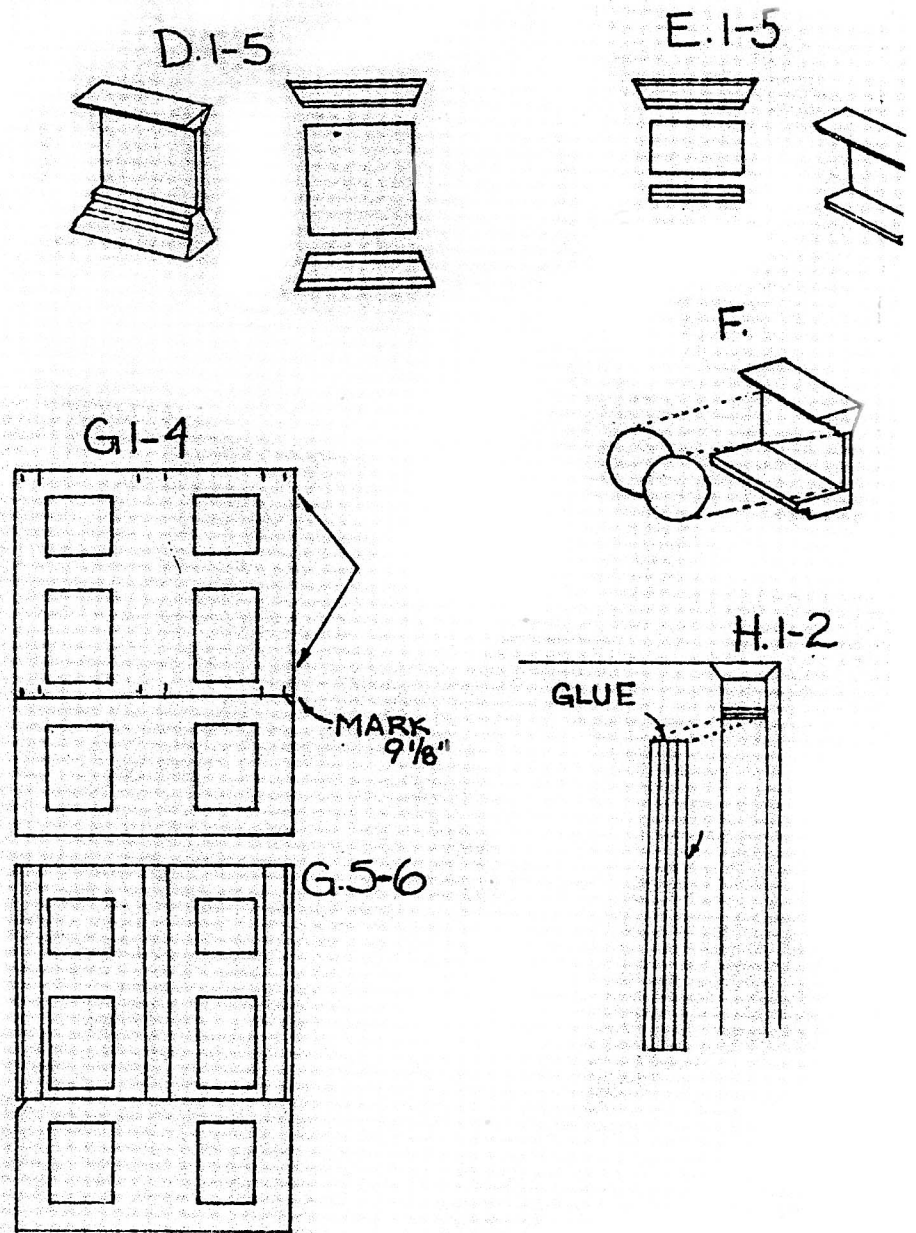

Section VI

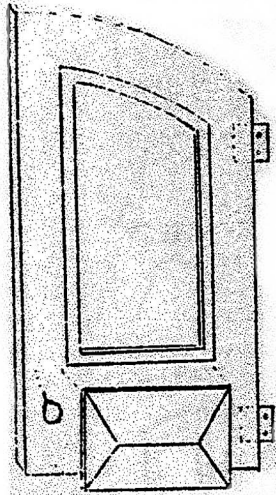
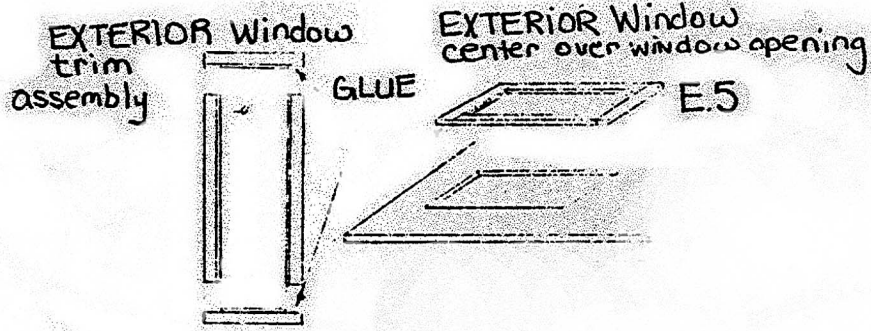

G.+H.1-3

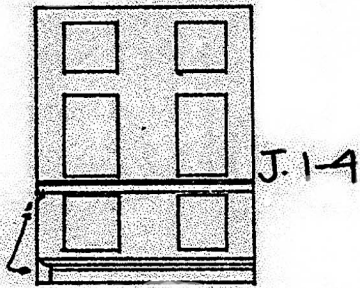

J.5-9

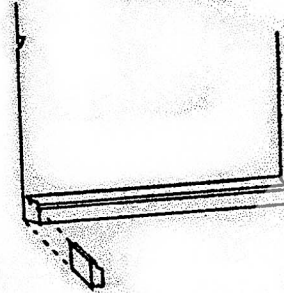

K.3-4

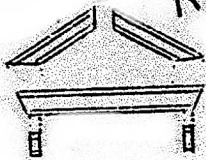

K.6-8

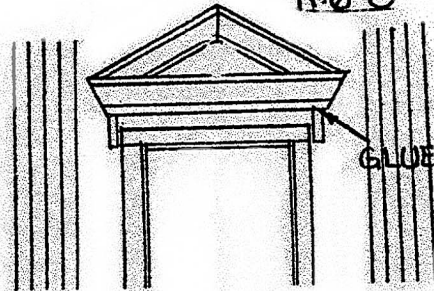

Section VI

L.1-4

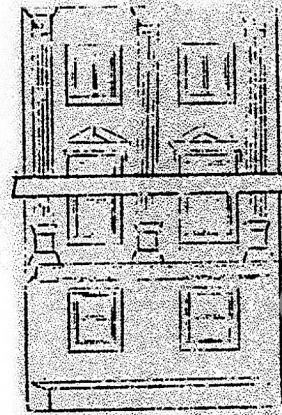

H.3

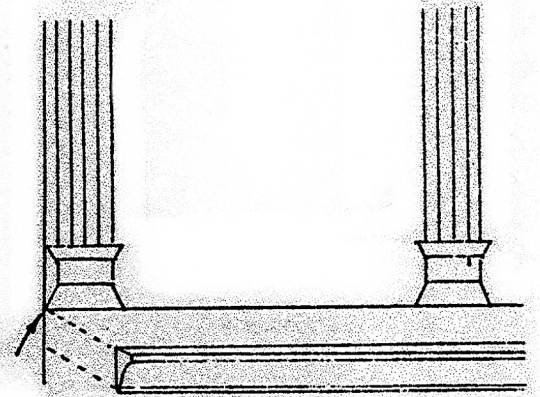

Section VII

CHIMNEY ASSEMBLY

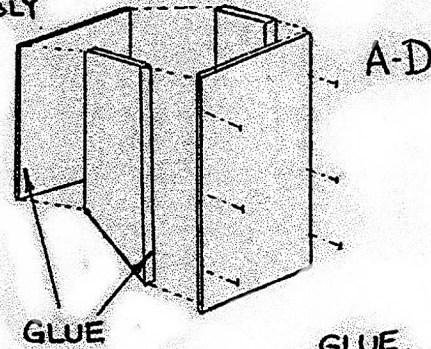

A-D.
TRIM ATTACHING

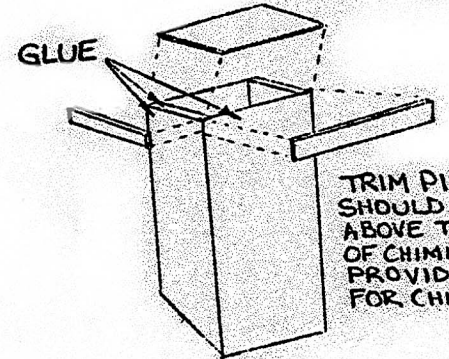

TRIM PIECE SHOULD EXTEND ABOVE THE TOP OF CHIMNEY PROVIDE A SPACE FOR CHIMNEY

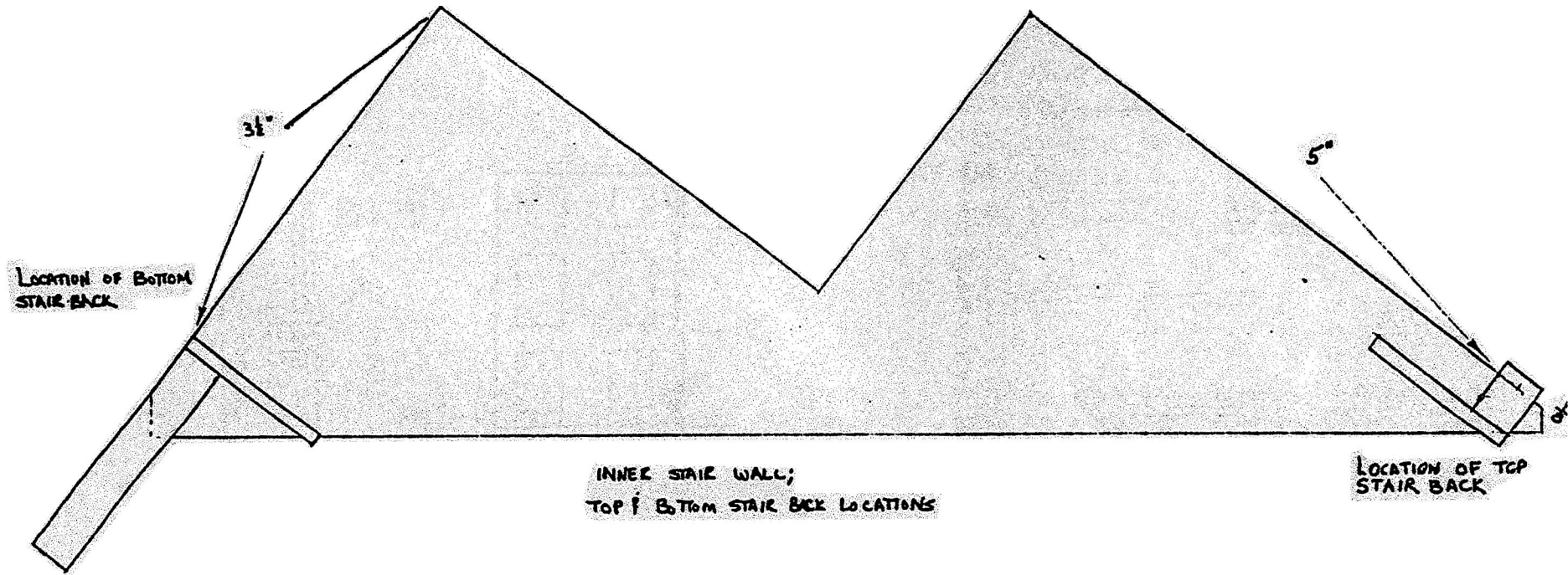

Section VIII.

1-4

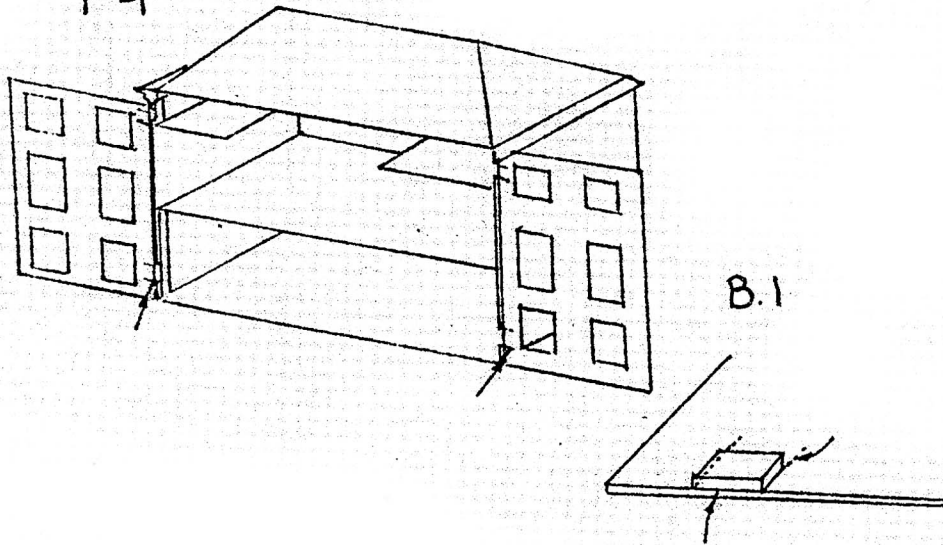

Section X

B.1-2

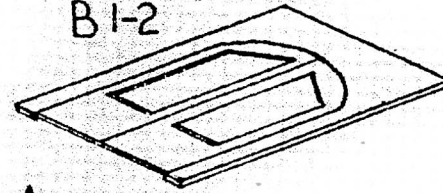

A.6

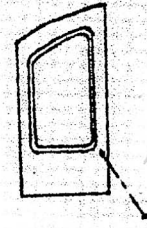

B.4-7

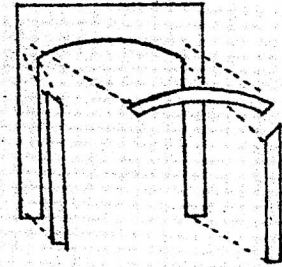

Section IX.

B.1-4

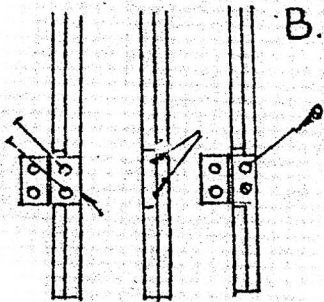

C.1-7

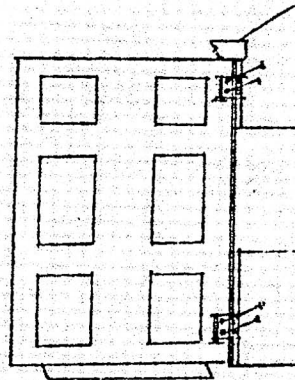

INTERIOR DOOR TRIM

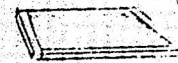

C.1-2

PLEXIGLASS

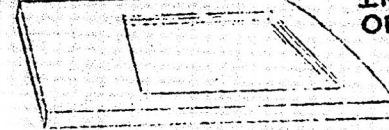
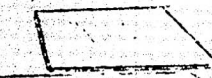

INSIDE OF DOOR

D.1-1

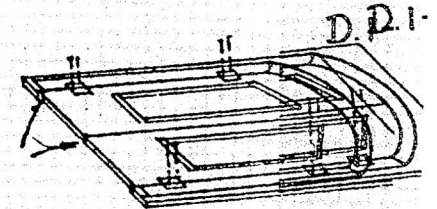

FOLD OVER

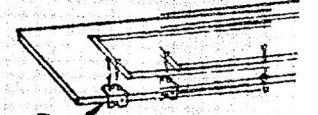

E.1-2

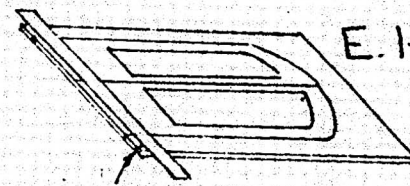

MARK

Section X

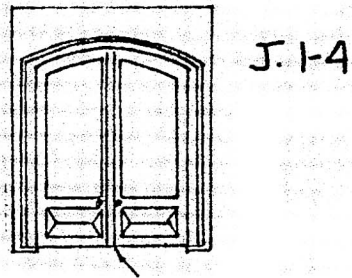
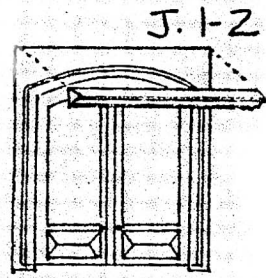
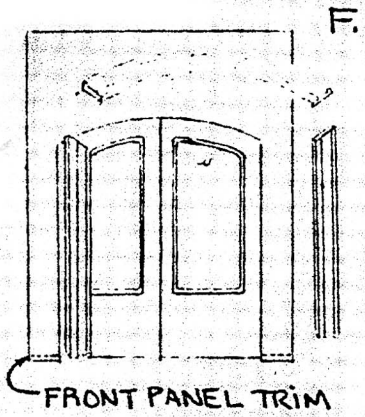

Section XI

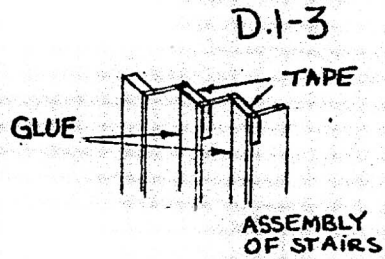
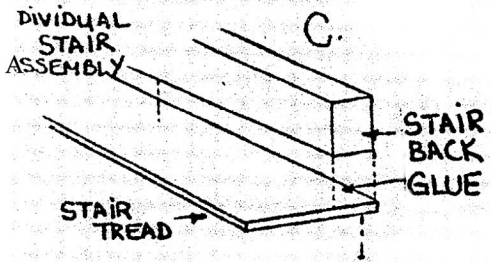

Section XII

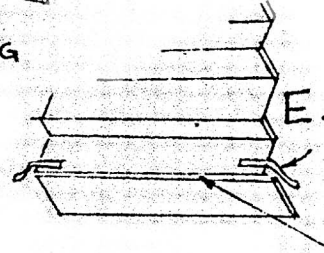
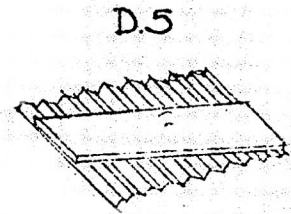
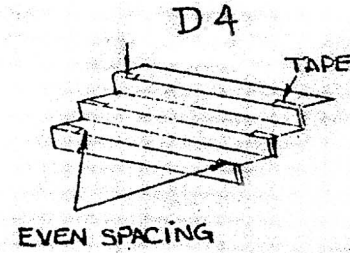

SECTION 4.XII

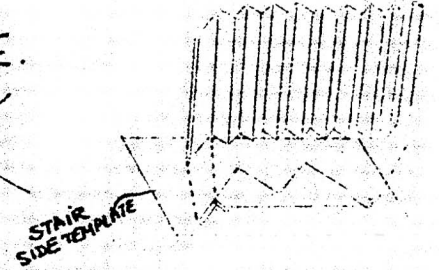

Section XIII

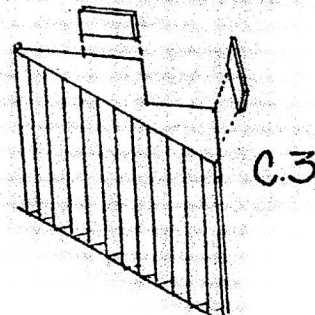
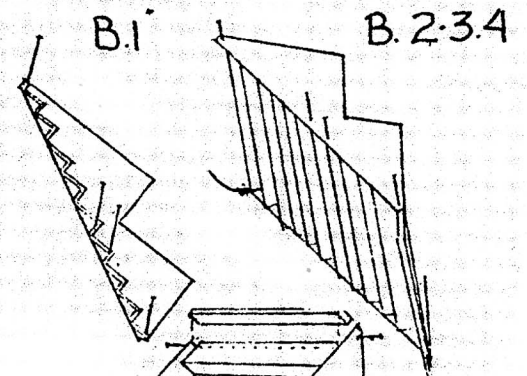
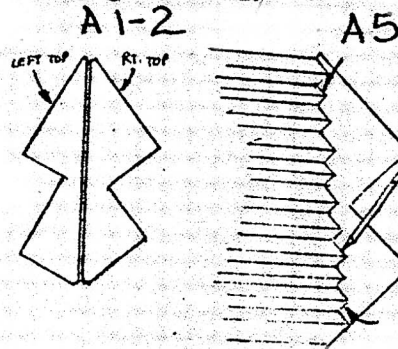

Section XIII

A.1-3

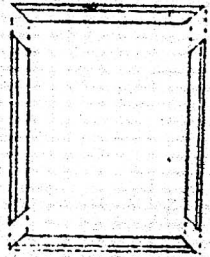

B.&C

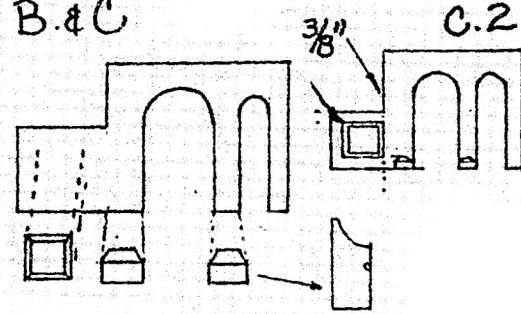

Section XIV

B&C.

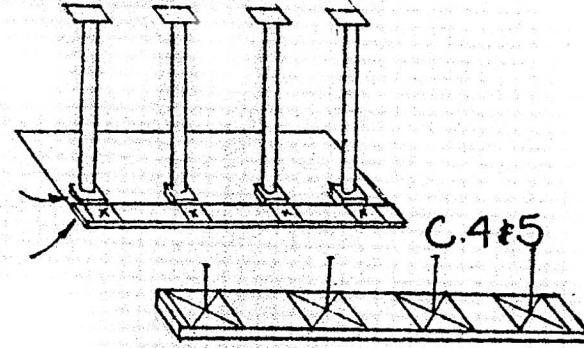

TRIM TOP
FRONT CORNER OF
SIDE PANELS TO
MEET SIDE LEDGE
MOULDING

Section XV

1.

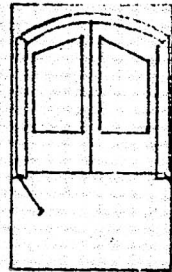
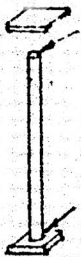

4.

D.1-5

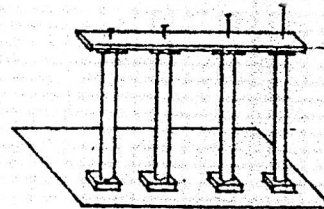

6-7

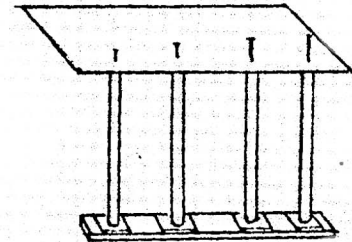

Section XVI

PORCH FLOOR WITH POST BLOCK LOCATIONS

A.1-3

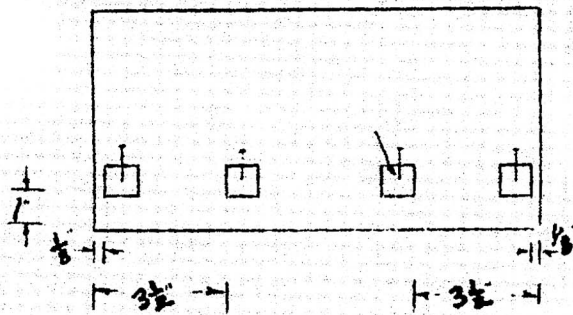

Section XVII

C.1

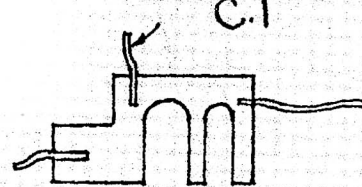

C.3-5

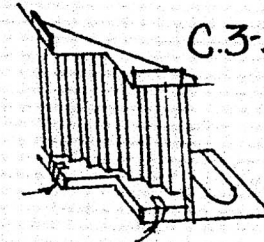

C.2



Section XVI

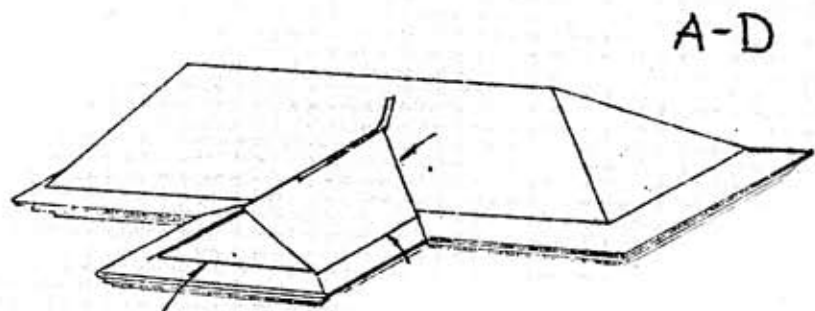

Section XVII

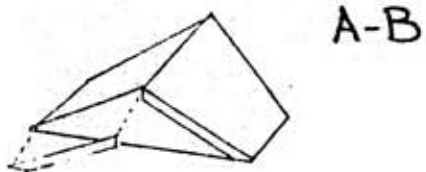

Section XVIII

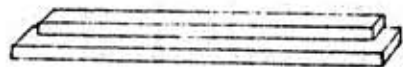

Section XIX

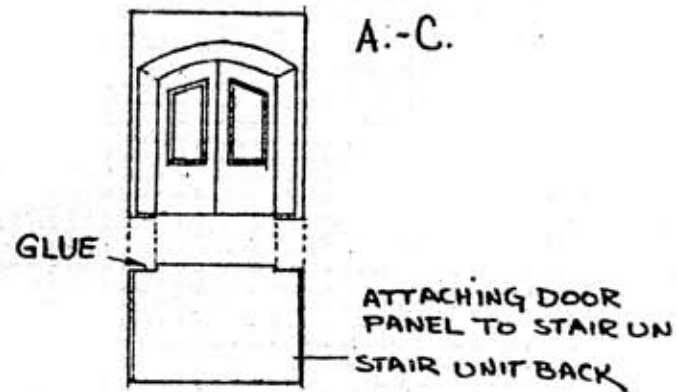

Section XXI

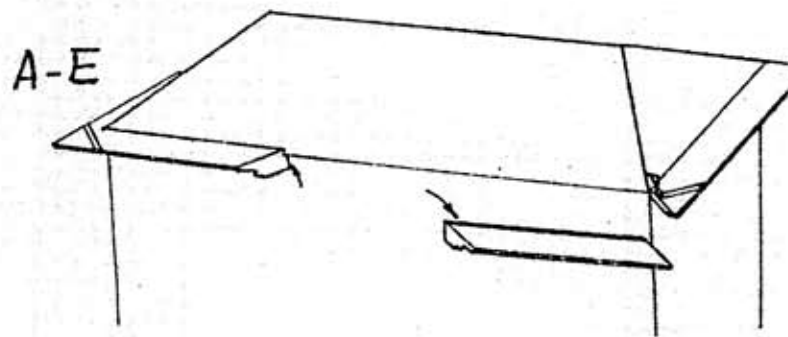
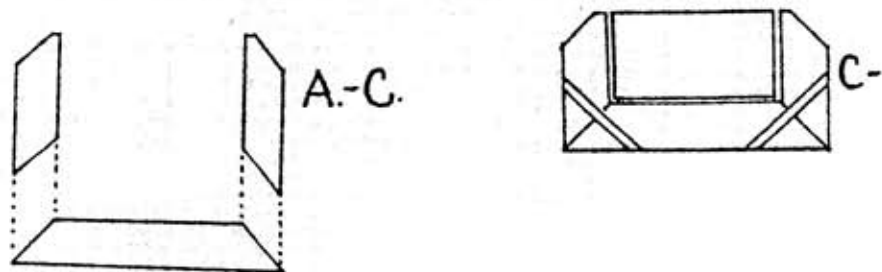

Section XVI

D.1-5

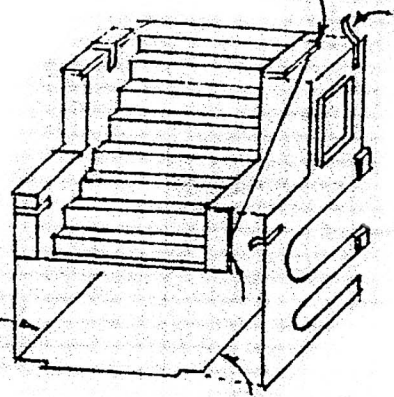

D.6-7

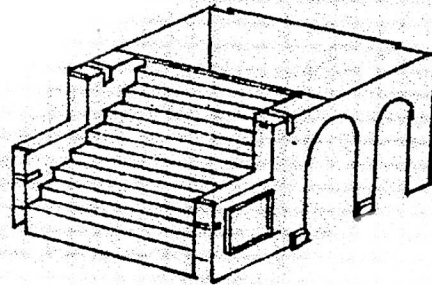

Section XVII

A-D.

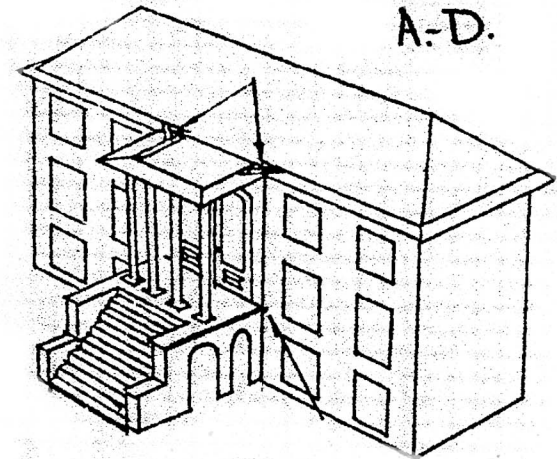

Section XVII

A-E

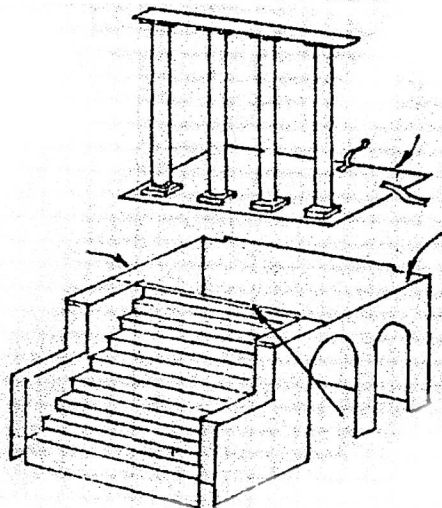

F.

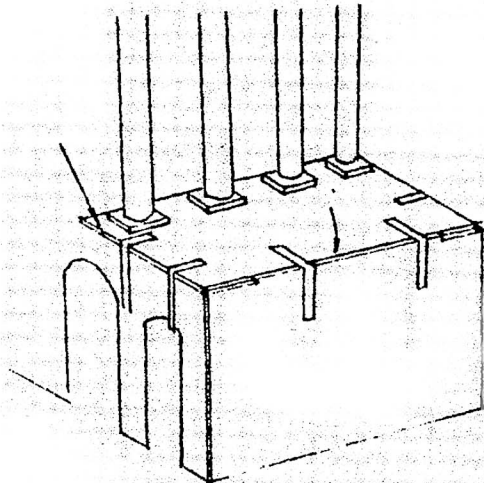

Section XVIII

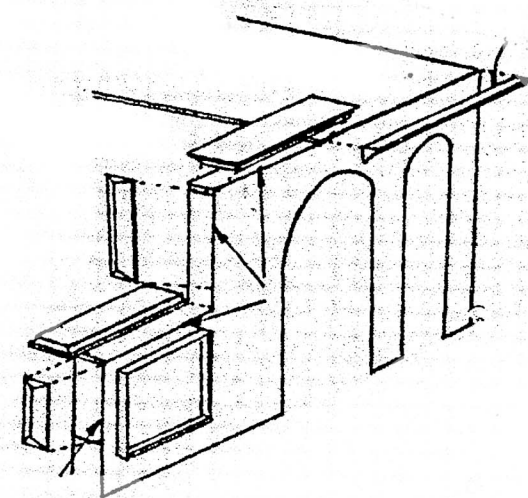

Section XXIV

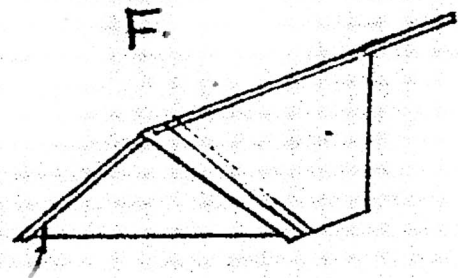
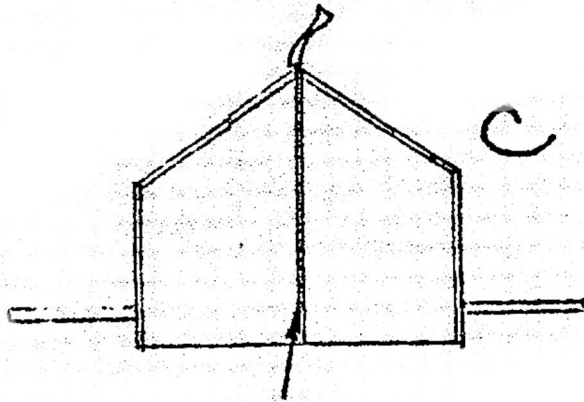
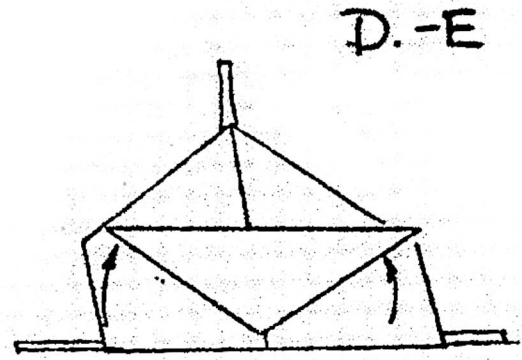
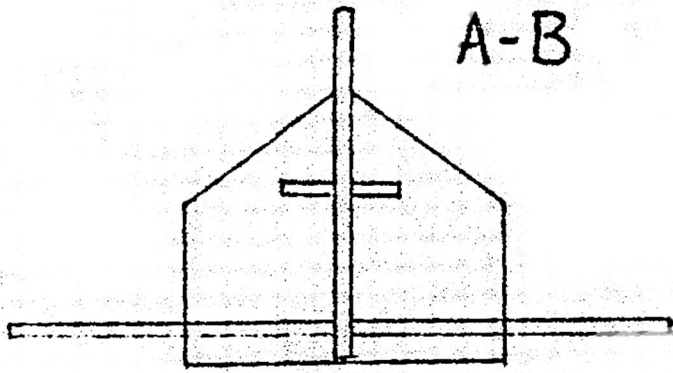

Section XXV

