

THE OLD VILLAGE SHOP ECONO-KIT

by

WALMER DOLLHOUSES
2100 Jefferson Davis Hwy.
Alexandria, Va. 22301
(703) 548-8804

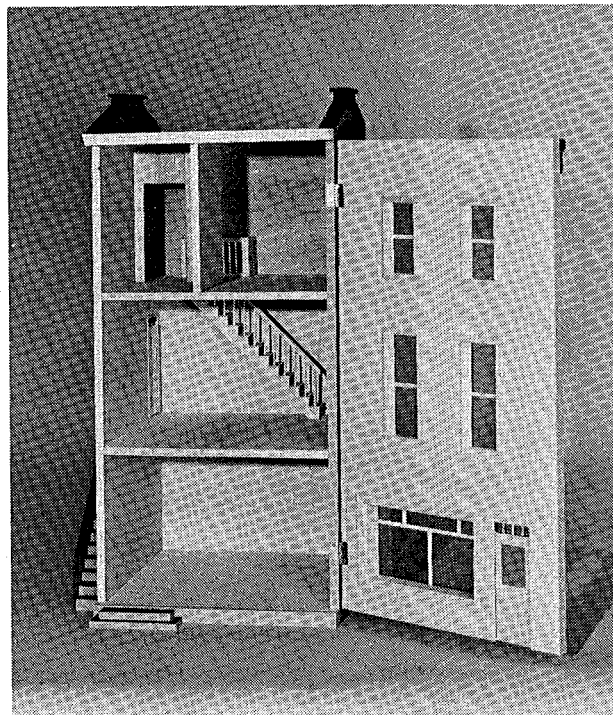
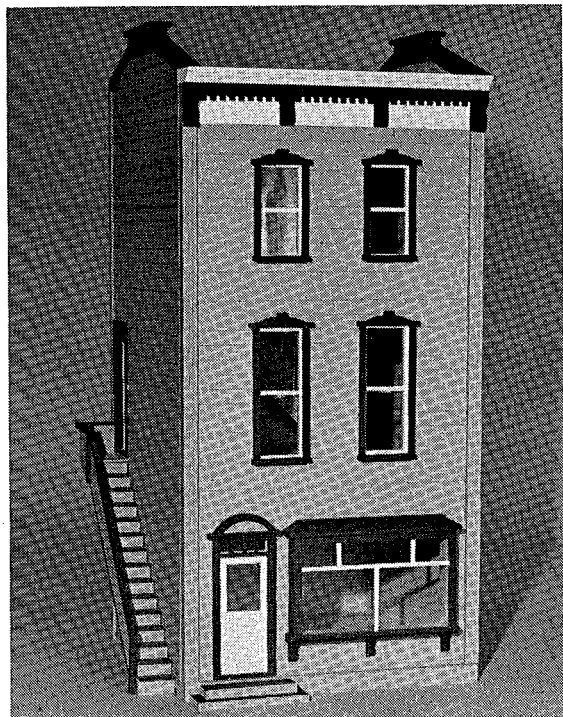

SQUARE is the key word in the assembly of the Old Village Shop.

WHERE is equally important. Be sure to use a level and flat surface for assembly. If you build it square on a level and flat surface, it will really be square. If you build it on an uneven surface, it will shift out of square whenever it is moved to another surface. This is especially true of such a tall and narrow structure.

Two helpful notes:

1. When nailing two small parts together, insert the nail almost through the first part before joining it with the second part. Then make the joint and nail through.
2. Paint small parts before assembly with larger parts of different color, e.g. brackets, dentil, window trim, pane dividers, etc.

MAJOR PARTS

OLD VILLAGE SHOP

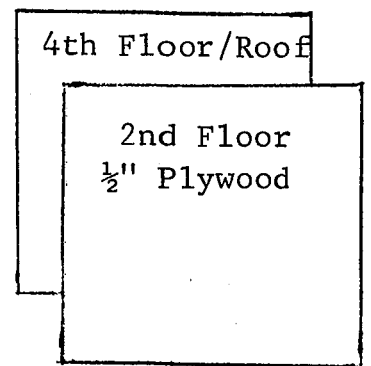
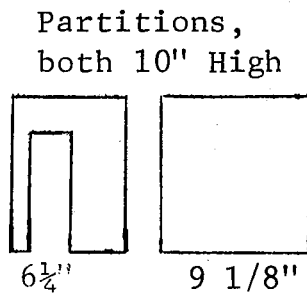
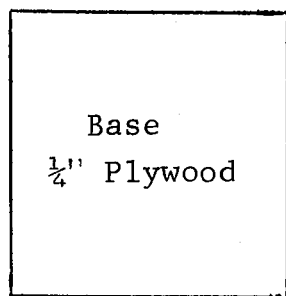
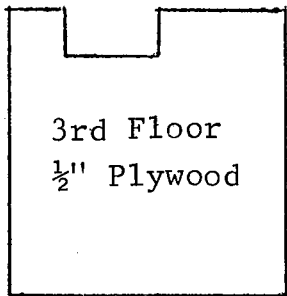
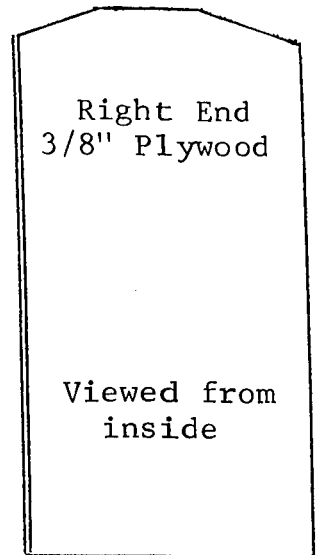
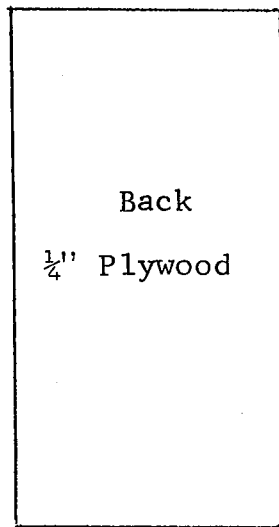
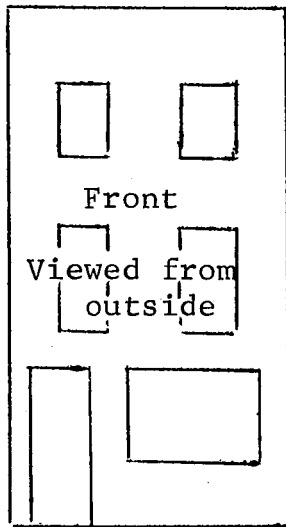
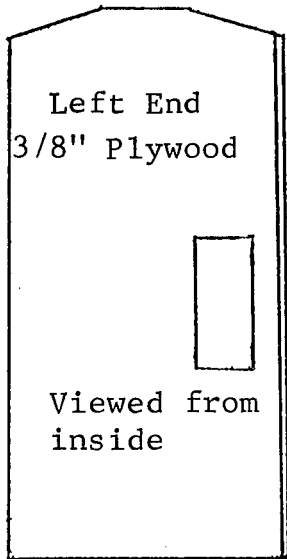

AUXILIARY PARTS

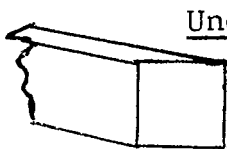

Underframe
 $3/4'' \times 3/4''$
 2 pcs. 15 $3/8''$
 2 pcs. 13 $7/8''$

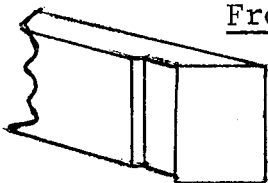

Front Sill
 16 $1/2''$

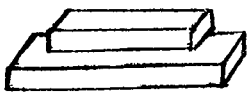

Front Step

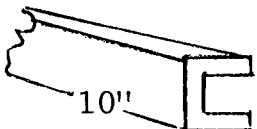

Facing Channel
 10''

Plus:

- Exterior Stairs
- Interior Stairs
- Landing Rail
- Store Door
- Residence Door
- 2 Pcs. Long Interior Window
- 2 Pcs. Short Interior Window

Top Molding

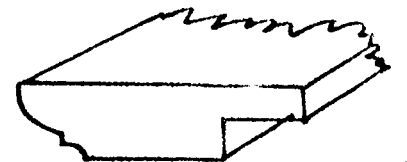

Stancions

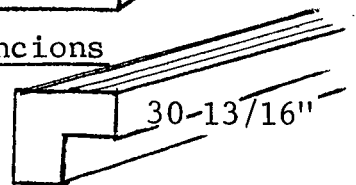

30-13/16''

L-Strip

31 $7/8''$

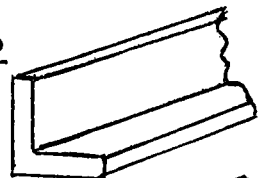

Floor Facing

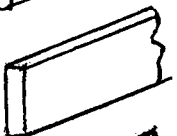

Pane Divider



LONG BOYS SUBPACK

1 pc. Left Stancion	30 7/8"
1 pc. Right Stancion	30 7/8"
2 pcs. Corner Molding (L-strips)	31 7/8"
2 pcs. Underframe	3/4 x 3/4 x 15 3/8"
2 pcs. Underframe	3/4 x 3/4 x 13 7/8"

SHORT BOYS SUBPACK

1 pc. Top Molding	16 9/16"
1 pc. Front Sill	1" x 1" x 16 9/16"
2 pcs. Floor Facing Strips	1/8" x 1/2" x 15 3/8"
1 ea. Brackets Facing	3/16" x 2 1/8" x 15"

STORE WINDOW SUBPACK

1 ea. Store Window Top Frame
1 ea. Store Window Bottom Frame
2 ea. Store Window Side Frames (1 left, 1 right)
1 ea. Store Window Sill
1 ea. Store Window Lintel

FIREWALL CAP SUBPACK

2 pcs, Front
2 pcs, Center
2 pcs, Rear
2 pcs, Chimney Cap

STYRENE STORE WINDOW PANESTAIRS TUBE SUBPACK

1 ea. Interior Stairs
1 ea. Hardware Subpack (in coin envelope)
3 ea. hinges
8 ea. hinge screws (1/2" x #4)
2 ea. flat head screws (1" x #5)
1 ea. round head screw (3/4" x #6)
26 ea. nails (1" x #17)
16 ea. nails (1 1/2" x #17)
1 ea. Interior Trim Subpack (banded)
2 ea. Store window top/bottom frame
1 ea. Store window side frame
1 ea. Facing channel for partition
3 pcs. Window pane dividers
4 pcs. Long window exterior side frame
4 pcs. Short window exterior side frame
Subpack label
1 ea. Front (#1006) Door with Interior Trim
1 ea. Side (#1003) Door with Interior Trim
1 ea. Exterior Stairs

STAIRS TUBE SUBPACK CONTINUED

1 ea. Exterior Trim Subpack (Baggie)

- 3 pcs. Dentil Trim
- 4 ea. Large Brackets
- 3 ea. Small Brackets
- 1 ea. Door Lintel
- 1 ea. Door Hood
- 1 ea. Twist Latch
- 4 ea. Window Lintels
- 4 ea. Window Sills
- 4 ea. Window Undersills
- 1 ea. Subpack Label

1 ea. Exterior Stair Landing Subpack (Bagged)

- 1 ea. Landing Block
- 1 ea. End Board
- 1 ea. Side Board
- 1 ea. End Handrail
- 1 ea. Side Handrail
- 1 ea. Subpack Label

- 1 ea. L-Rail
- 1 ea. Front Steps
- 2 ea. Small Assembled Windows
- 2 ea. Large Assembled Windows

Store Window

(See Steps 4 and 17)

Left and Right Side Frames
Top Frame
Bottom Frame
Lintel
Sill
3 Brackets (small)
Window Pane
Pane Dividers

Firewall Cap

(See Step 15)

2 Pcs. Front
2 Pcs. Center
2 Pcs. Rear
2 Pcs. Chimney Cap

Landing for Exterior Stairs

(See Step 2)

Landing Block
Side Board
End Board
2 Pcs. Mitered Handrail

Front Trim

(See Steps 16 and 17)

Top Facing Board
4 Pcs. Large Brackets
3 Pcs. Dentil Molding
4 Pcs. Window Lintel
4 Pcs. Window Sill
4 Pcs. Window Under-sill
4 Pcs. Long Window Side Frame
4 Pcs. Short Window Side Frame
1 Pc. Door Lintel
1 Pc. Door Hood
1 Pc. Twist Latch

Hardware

2 Pcs. Hinges
8 Pcs. Screws 1/2" x #4
2 Pcs. screws 1" x #5
1 Pc. Screw 5/8" x #6
26 Nails 1" x #18
16 Nails 1 1/4" x #16

SEQUENTIAL ASSEMBLY INSTRUCTIONS

for the

OLD VILLAGE SHOP

Tools & Supplies

Needed: Square, small saw or mat knife, tape measure, hammer, small screwdriver, masking (or scotch) tape, sandpaper, white (or carpenters) glue, drill with 3/32" bit, several squeeze clamps or C-clamps.

1. SANDPAPERING

Extensive sand papering is not required since almost all edges of the plywood are covered with molding, corners, or facings. Sandpaper only to the extent necessary to remove frayed wood that would inhibit good fits of the parts during assembly.

Note: The better side of the plywood (the smoother and tighter grained side) should be selected to become the sides which are painted and/or exposed.

2. SUB-ASSEMBLY OF LANDING FOR EXTERIOR STAIRS

Glue the side and end boards to the landing block. A rubber band can be used to hold the joints firm until the glue sets.

Glue the mitered hand rails to the top edges of the side and end boards. Get a good fit at the mitered corner.

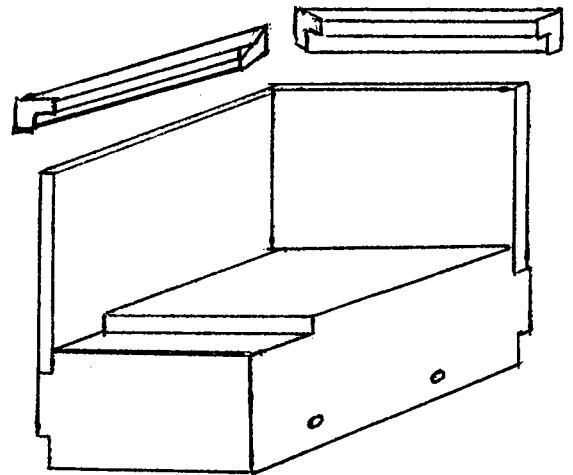

3. INSTALLATION OF THE UNDERFRAME ONTO THE BASE

Be sure the base is 1/4" plywood (not 1/2")

Select the better side of the plywood - the smoother and closer grained side - place it down. Then glue the parts of the underframe to each other and to the base flush to the outer edges of the plywood. Apply weight (books maybe) to assure solid glue joints. Allow 15 minutes for glue to set.

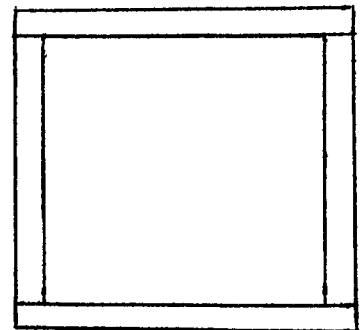

4. SUB-ASSEMBLY OF STORE WINDOW INNER FRAME

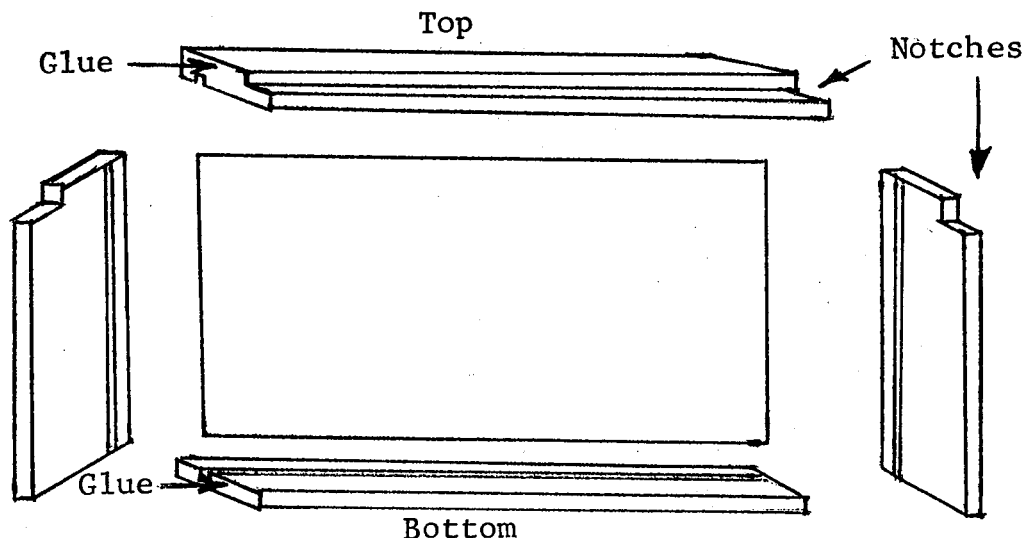

Slip the Window pane into the slit in the top and bottom frames. Apply glue to the ends of the top and bottom frames and fit the ends into position over the protruding edges of the window pane and against the butt ends of the top and bottom frames. Be sure the notches in the ends are matched with the notches in the top. Insert 1" nails (the thin ones) through the ends into the top and bottom to keep the joints tight until the glue sets. Fit the inner frame into the opening of the front, checking to be sure it is square. Then glue the lintel and sill onto the top and bottom of the inner frame as shown. Take care to avoid gluing the window to the front of the doll-house.

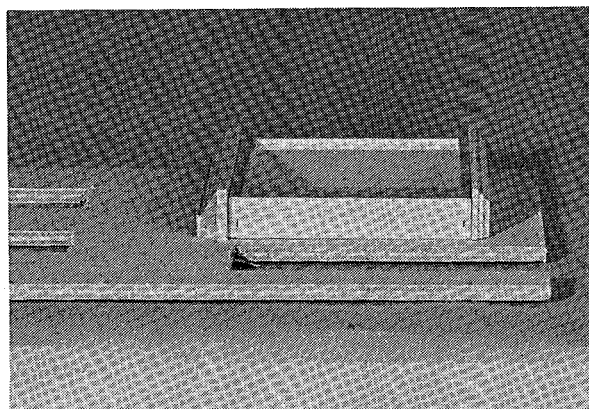

5. SUB-ASSEMBLY OF TOP MOLDING ONTO 4th FLOOR/ROOF

Glue the joint as shown, flush at each end. Clamp until set.

6. SUB-ASSEMBLY OF EXTERIOR STAIRS AND THE EXTERIOR LANDING

Apply glue to the mating surfaces and couple the stairs and landing as shown.

In the absence of the clamp, small nails can be used to hold the joints firm until the glue sets.

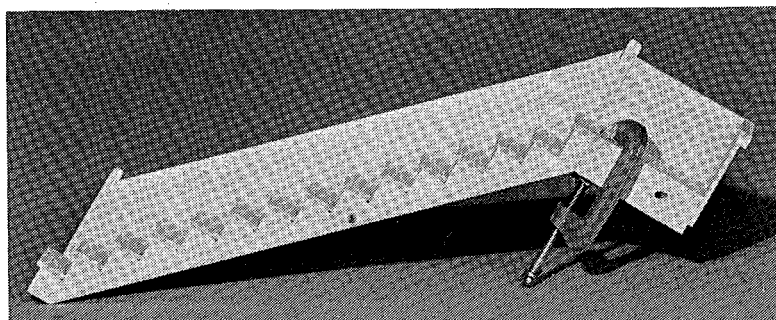
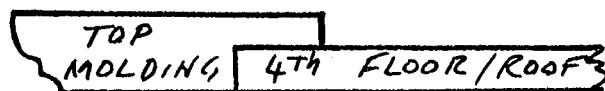

7. SUB-ASSEMBLY OF CORNER STANCIONS ONTO FRONT

The left and right stancions are not identical. Orient them so that the flat space beyond the grooved cut is at the top. Then glue and clamp the notches in the stancions onto the edges of the front as shown. BE SURE THE DOOR is on a flat surface while glue is drying. The door can adopt a warp or twist if the glue dries in a non-level position.

NOTE: An extra pair of helping hands are useful in steps #8 and #9 to hold parts steady and firmly in place while nailing.

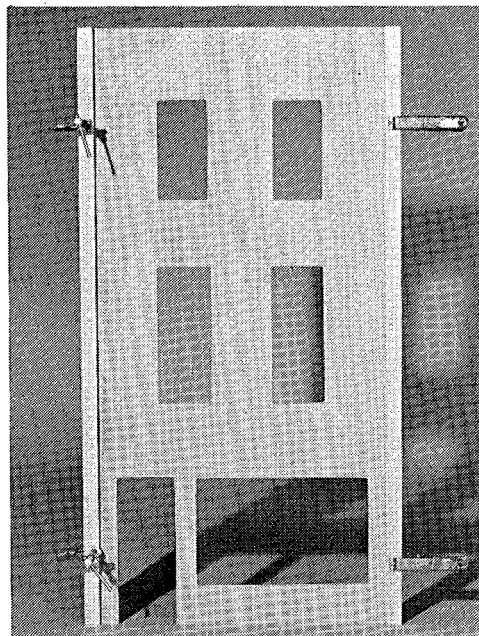

8. INSTALLATION OF BACK ONTO BASE Use 1" #18 (thin) nails.

Start three nails 1/2" up from the lower edge of the back. Set the base on edge and apply glue to the underframe. Then using the 2nd and 3rd floors for support as shown, adjust the back to overhang each edge equally (3/16") and be flush with the bottom edge of the underframe (VERY IMPORTANT FOR SQUARENESS). Holding everything firmly in place, drive the nails half way. Recheck for even overhang and flush at the bottom edge, then drive nails all the way.

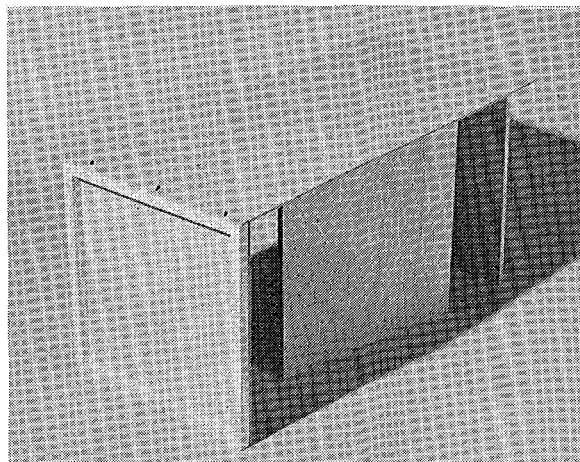

9. INSTALLATION OF ENDS ONTO BASE AND BACK Use 1" #18 (thin) nails.

Slip the left end into position as shown - so that the overhang of the back engages the rabbeted notch in the end. Glue the mating surfaces and nail through the back into the end. Nail at a slight angle so the nail goes to the center of the 3/8" thick end. Being sure all mating edges are flush, check for square and nail the bottom edge of the end to the underframe of the base. Repeat to install the right end.

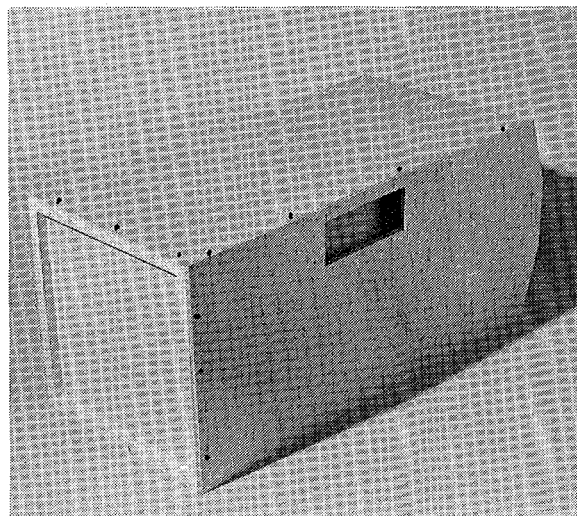

10. INSTALLATION OF FLOORS Use $1\frac{1}{4}$ " #16 (heavy)

With the structure set up as shown, use the two partitions (10" high) as spacers to establish the level of the second floor. Make marks on the exterior $11\frac{1}{4}$ " up from the bottom edges of the ends and back.

With the ends snug tight against the floor, check for square between the base and ends. This is the most important square-check. It is necessary later for the front to hang properly. If the ends are not square with the base, check to be sure your building surface is level. If necessary, use some force to flex the structure to become as square as possible.

With good side of plywood up, apply glue to the mating edges of the floor and, holding the ends square, nail through the ends and back into the second floor. Note: The second floor will be above the bottom of the side door opening by about $1/8$ ".

Move the partitions up onto the second floor and repeat the procedure to install the 3rd floor, (with stairwell on the back wall and toward the left rear corner). See Step #13. Nail marks are up $21\frac{3}{4}$ ".

Repeat again for 4th floor/roof installation. Nail marks at $32\frac{1}{4}$ " up.

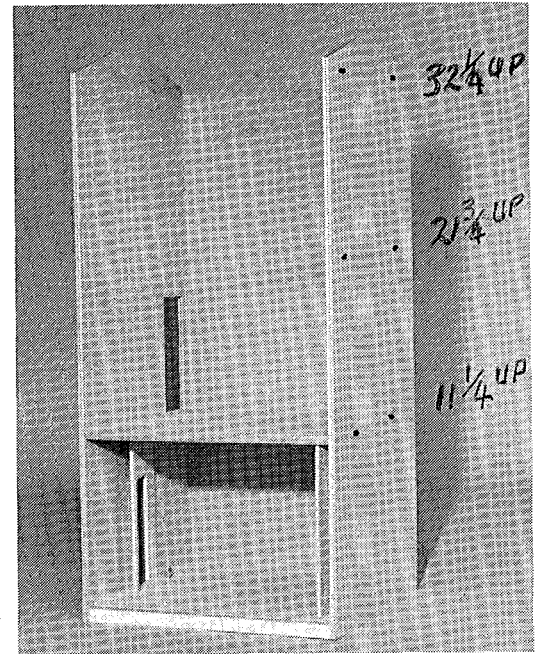

11. INSTALLATION OF L-STRIPS, FRONT SILL AND FLOOR FACING STRIPS

The L-strips are glued onto the front edge of the ends as shown.

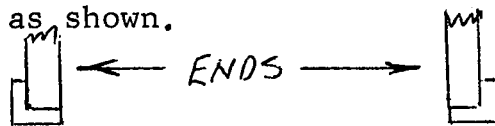

If one side of the "L" is thicker than the other, place the thicker side on the front edge of the end. The L-strip should be up tight under the top molding. Use masking or scotch tape to keep pressure on the joints until the glue is set.

Cut floor facing strips to fit between the L-strips. Glue the facing strips to the front edge of the floors, securing the joints with tape. Glue the front sill onto the front edge of the base. Use $1\frac{1}{4}$ " nails.

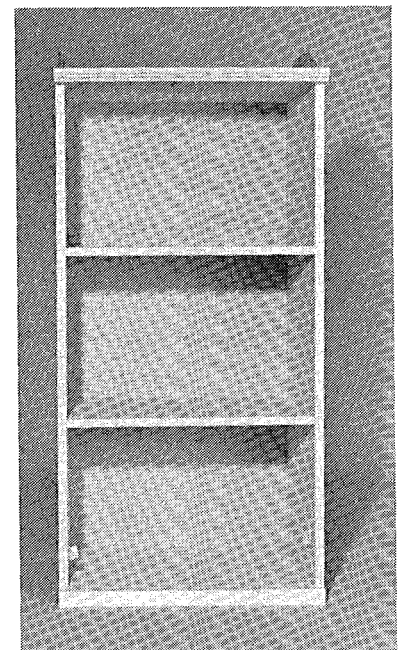

12. INSTALLATION OF FRONT

The front is hinged onto the right end. Open the hinges and fold them back like this:

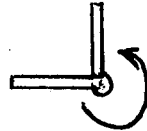

Place them on the right L-strip as shown and mark the locations of the top holes (only) of each hinge on the front face of the L-strip. Drill a $3/32$ " diameter hole about $3/8$ " deep and drive a hinge screw ($1/2$ " x #5) into each of the two holes.

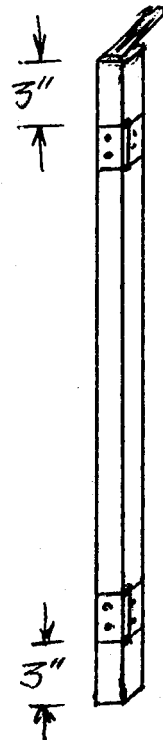

With the house on its back, lay the front in place as shown. If everything is good and square, the outside of the front should fit flush with the L-strips and with even spacing on top and bottom.

With the front in this position, make marks where the top and bottom of the hinges contact the front stancion. You will note that the rotating pin of the hinge protrudes beyond the outer edge of the front and end. Remove the front and place it face down on a flat surface.

Remove the hinges from the L-strip and with hinges folded open as above, place them between the marks on the stancion. Mark the top holes (only), drill and install screws. Stand the house up and re-install the top hinges on the L-strip by reinstalling the top screws. Test the fit of the door. It should swing closed with even spacing all around. If it does, drill holes and install the remaining screws. If it does not, remove the single screw that will allow adjustment in the proper direction. Make that adjustment and use the bottom hole to install a screw at the new location. The hole can be plugged and redrilled. Repeat as necessary to obtain a proper functioning door.

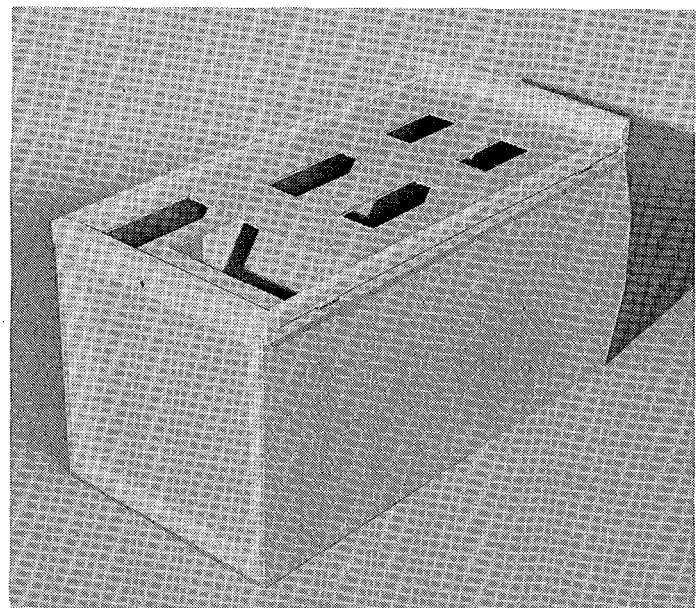

13. INSTALLATION OF STAIRS AND UPSTAIRS RAIL

Attach the assembled exterior stairs and landing to the left side of the house as shown on the front cover, using pilot holes drilled in the left end just under the 2nd floor - and the two 1" screws provided.

The interior stairs slip up through the stairwell from below. The top tread sets on the 3rd floor. It can be glued in place if desired. The upstairs rail sets in place around the stairwell as shown.

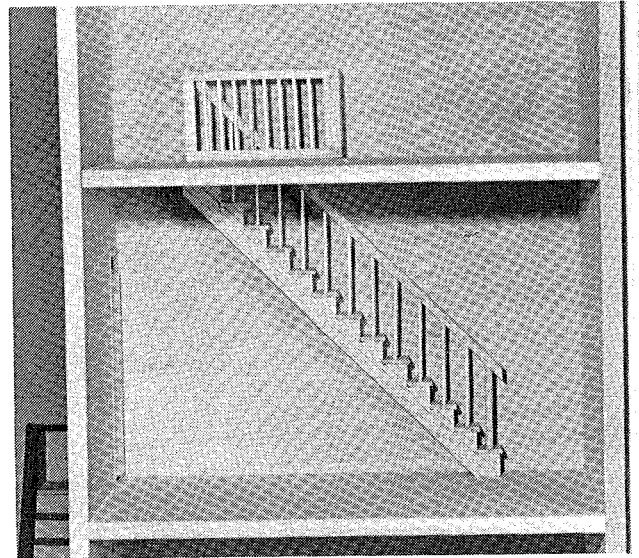

14. INSTALLATION OF PARTITIONS

The partitions are intended as a small bathroom on the top level. Glue the facing channel to the front edge of the 11½" partition. Install as shown.

NOTE: At this point, be sure to be aware of the desirability of painting trim before installation.

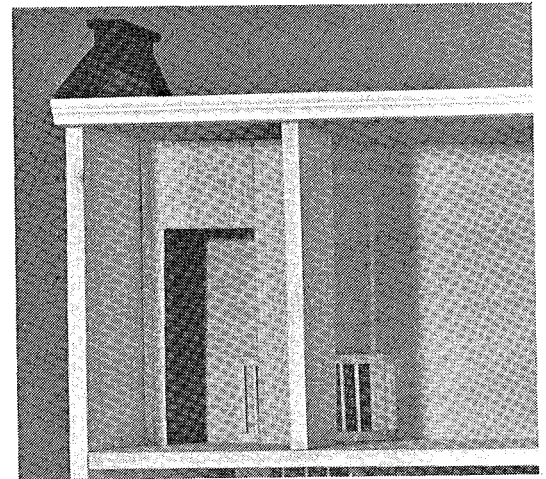

15. INSTALLATION OF FIREWALL CAP AND CHIMNEY CAP

Starting flush at the rear of the ends, glue the rear, center, and front firewall caps as shown. Glue the chimney cap centered on the center section of firewall cap.

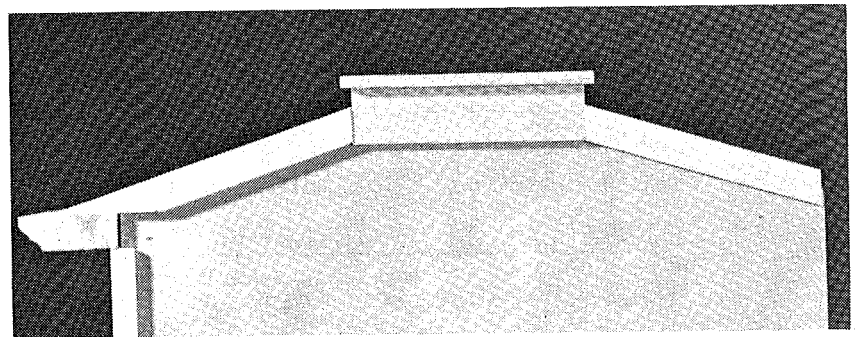

16. INSTALLATION OF INTERIOR WINDOWS AND FRONT TRIM

The assembled windows are to be installed in the openings from the inside.

For the window trim, first glue the undersill strips to the bottom of the window sills. There are 4 long window side frames and 4 short ones. (They are packed with the interior door trim.) Starting at the top, install the window lintels, side frames, and sills as shown. The recessed edges of the side frames are to the inside of the window. Glue the top facing board between the stancions and then the large brackets and dentil trim in place as shown.

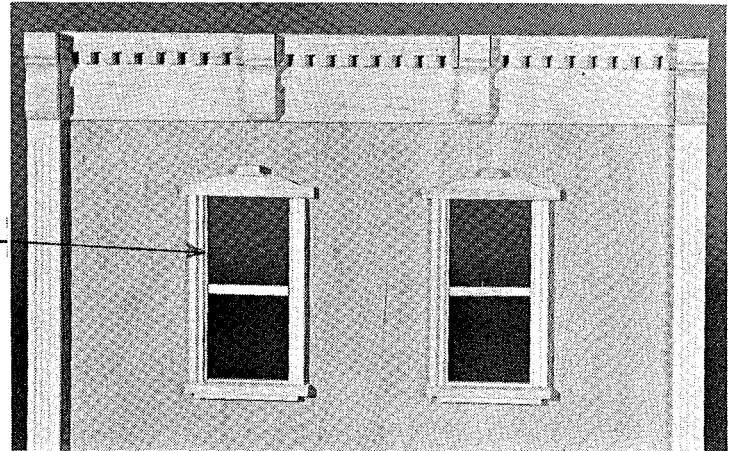
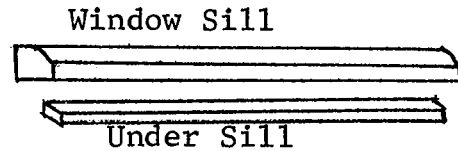

17. INSTALLATION OF DOOR AND STORE WINDOW

The door is glued into the opening from the outside as shown. Be sure the door does not protrude below the bottom edge of the front. Glue the horizontal door lintel and hood as shown. Install store window as shown - applying glue to the lintel and sill. Add small brackets as shown. Cut window pane dividers to fit as shown and glue (or press fit) as shown. Super T Hot Stuff or other cyanoacrylate adhesive is suitable for wood onto plastic.

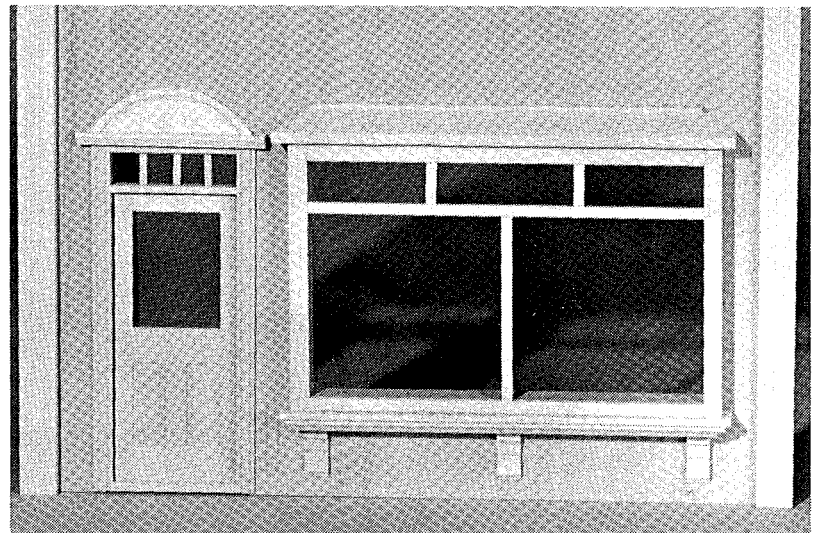

18. INSTALLATION OF INTERIOR TRIM ONTO STORE WINDOW AND DOORS

Glue the interior trim (pre-cut to fit) around the inside of the store window and doors.

19. TWIST LATCH

A wooden twist latch and screw (5/8" x #6 round head) are provided for optional use in holding the front of the house in the closed position.